

# CS 59Pa

CS 59Pa



**REYNAERS**  
aluminium



## CS 59Pa

---



### CS 59Pa (windows)

- 1 Fixed elements
- 2 Opening elements
- 3 Composed elements
- 4 Connections within the system

### CS 59Pa (doors)

- 5 Inward opening
- 6 Outward opening

### CS 59Pa Front (CS 59Pa-Fr)

### CS 59Pa Automatic Sliding Door (CS 59Pa-AD)

### CS 59Pa Swing Door (CS 59Pa-SD)

### CS 59Pa Clampable Door (CS 59Pa-CD)

## CS 59Pa (windows)



### 1 Fixed elements

#### Outer frames

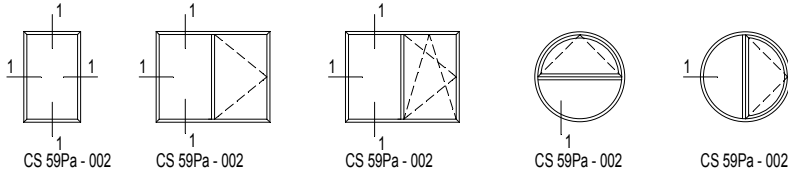

#### Shutter guide

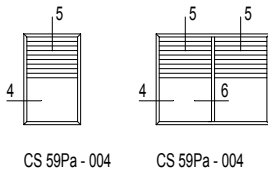

#### Drip cap

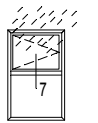

CS 59Pa - 005

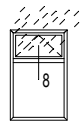

CS 59Pa - 005

#### Division in fixed frame

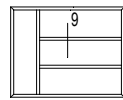

CS 59Pa - 007

### 2 Opening elements

#### Inward opening windows

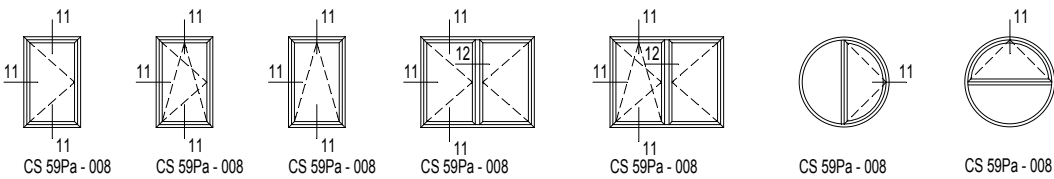

#### Outward opening windows

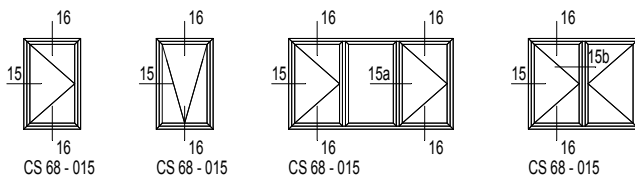

#### Division in window vent

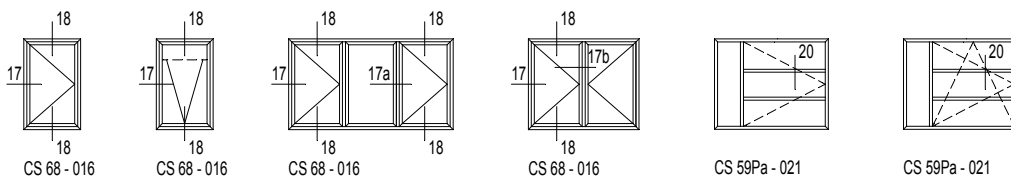

## CS 59Pa



### 3 Composed elements

#### Transom-mullion

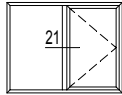

CS 59Pa - 022

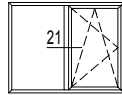

CS 59Pa - 022

#### Transom-mullion reinforced

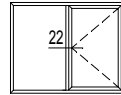

CS 59Pa - 025

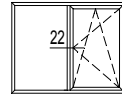

CS 59Pa - 025

#### Reinforcement profile

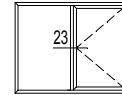

CS 59Pa - 026

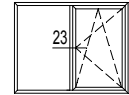

CS 59Pa - 026

#### Outer frames / Transom-mullion

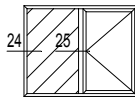

CS 59Pa - 030

#### Changeover profile outside glazing

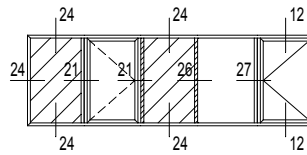

CS 59Pa - 033

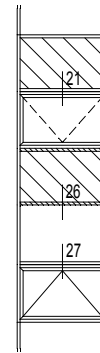

CS 59Pa - 033

### 4 Connections within the system

#### In the same plane

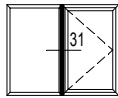

CS 59Pa - 034

#### Corner profiles

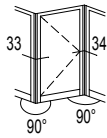

CS 59Pa - 036

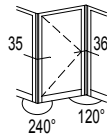

CS 59Pa - 038

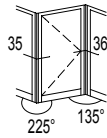

CS 59Pa - 038

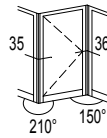

CS 59Pa - 038

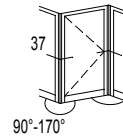

CS 59Pa - 039

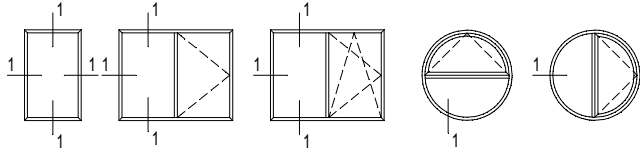

1

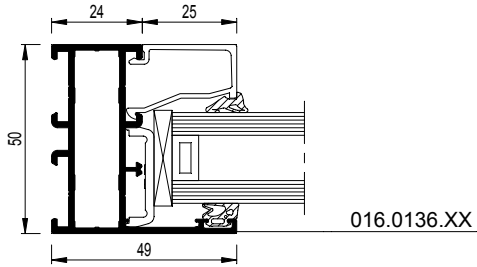

... .dxf  
... .dwg



1a

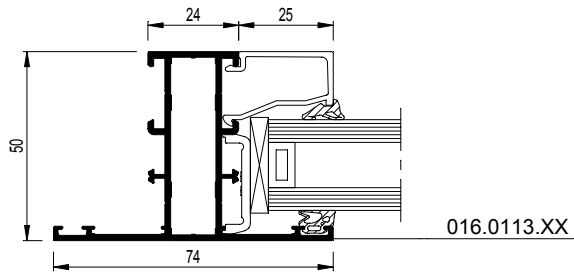

... .dxf  
... .dwg



1b

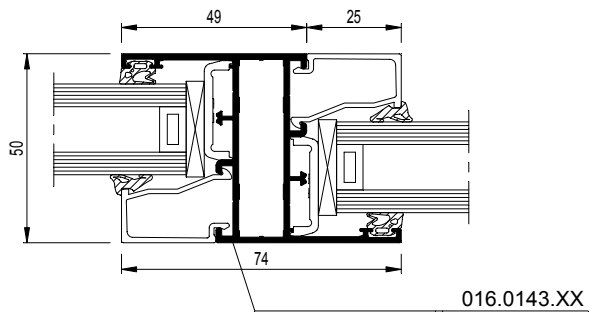

... .dxf  
... .dwg



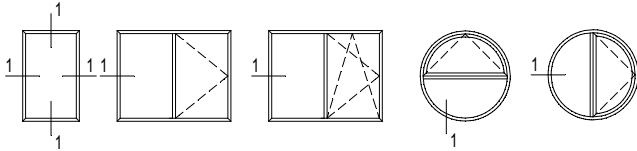

<p><b>016.0136.XX</b></p> <p><math>I_x = 10.135 \text{ cm}^4</math></p> <p><b>1</b> CS59Pa-001001.dxf CS59Pa-001001.dwg</p>	<p><b>016.0106.XX</b></p> <p><math>I_x = 9.933 \text{ cm}^4</math></p> <p><b>1</b> CS59Pa-001002.dxf CS59Pa-001002.dwg</p>	<p><b>016.0183.XX</b></p> <p><math>I_x = 12.836 \text{ cm}^4</math></p> <p><b>1</b> CS59Pa-001003.dxf CS59Pa-001003.dwg</p>	<p><b>016.0125.XX</b></p> <p><math>I_x = 15.047 \text{ cm}^4</math></p> <p><b>1</b> CS59Pa-001004.dxf CS59Pa-001004.dwg</p>
<p><b>016.0143.XX</b></p> <p><math>I_x = 13.090 \text{ cm}^4</math></p> <p><b>1</b> CS59Pa-001005.dxf CS59Pa-001005.dwg</p>			
<p><b>016.0113.XX</b></p> <p><math>I_x = 11.786 \text{ cm}^4</math></p> <p><b>1a</b> CS59Pa-001006.dxf CS59Pa-001006.dwg</p>	<p><b>016.0120.XX</b></p> <p><math>I_x = 14.610 \text{ cm}^4</math></p> <p><b>1a</b> CS59Pa-001007.dxf CS59Pa-001007.dwg</p>	<p><b>016.0114.XX</b></p> <p><math>I_x = 16.886 \text{ cm}^4</math></p> <p><b>1a</b> CS59Pa-001008.dxf CS59Pa-001008.dwg</p>	
<p><b>016.0143.XX</b></p> <p><math>I_x = 13.090 \text{ cm}^4</math></p> <p><b>1b</b> CS59Pa-001009.dxf CS59Pa-001009.dwg</p>	<p><b>016.0105.XX</b></p> <p><math>I_x = 7.021 \text{ cm}^4</math></p> <p><b>1b</b> CS59Pa-001010.dxf CS59Pa-001010.dwg</p>		

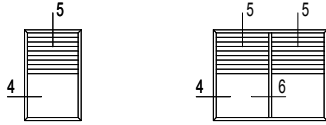

4

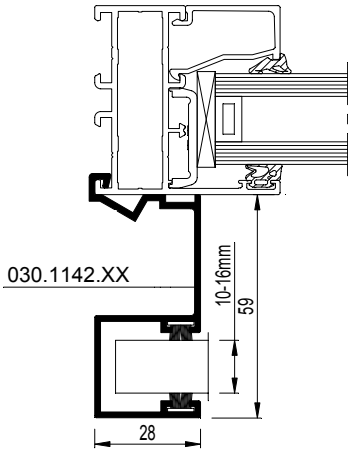

CS59Pa-004001.dxf  
 CS59Pa-004001.dwg

5

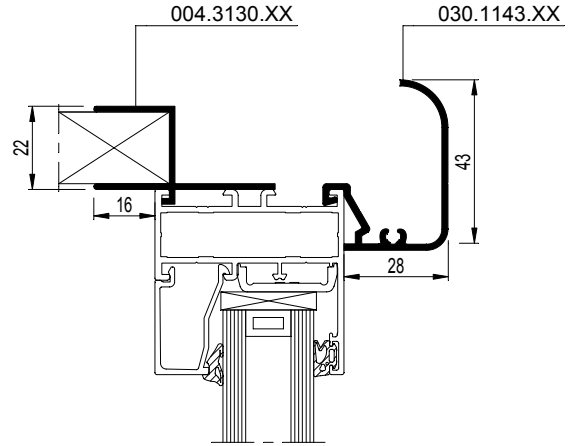

CS59Pa-005001.dxf  
 CS59Pa-005001.dwg

5

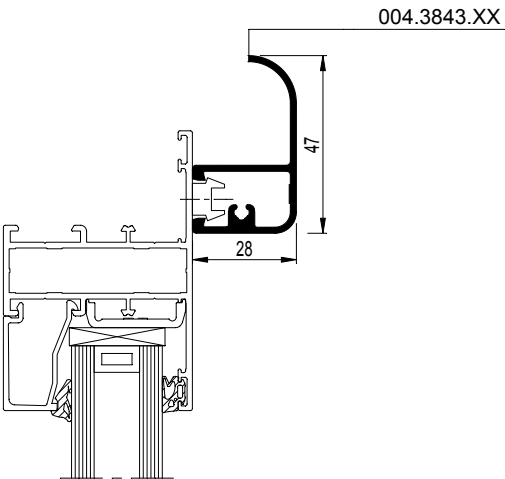

CS59Pa-005002.dxf  
 CS59Pa-005002.dwg



# CS 59Pa

Vaste elementen - Leklijst  
Eléments fixes - Rejet d'eau  
Fixed elements - Drip cap  
Feste Elemente - Wetterschenkel

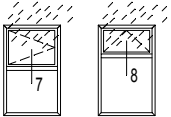

7

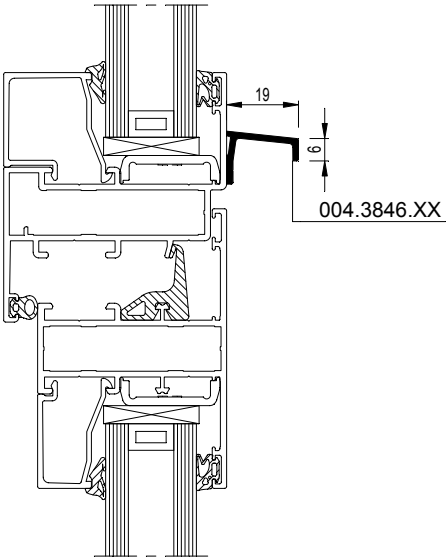

CS59Pa-007001.dxf  
CS59Pa-007001.dwg

8

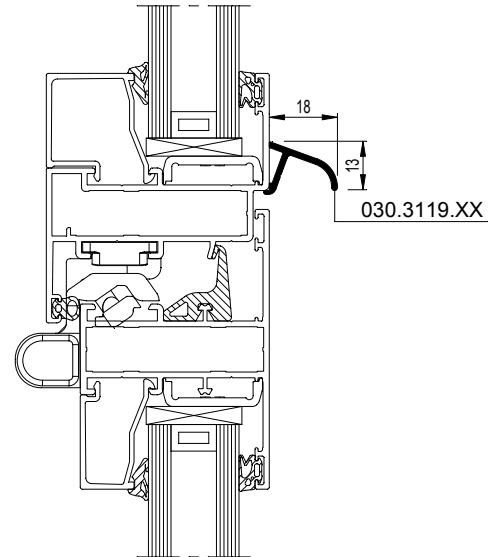

CS59Pa-008001.dxf  
CS59Pa-008001.dwg

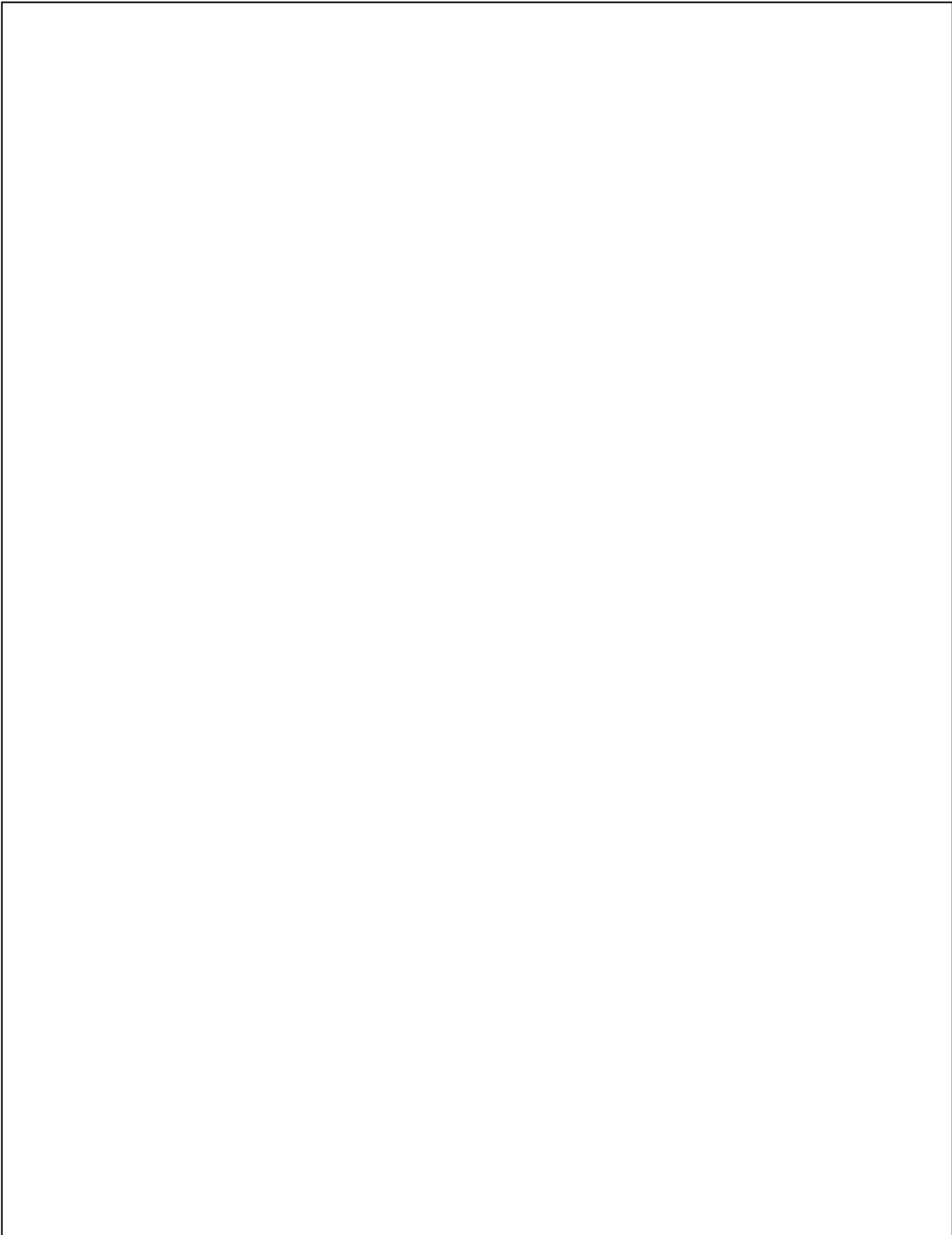

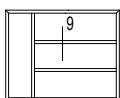

9

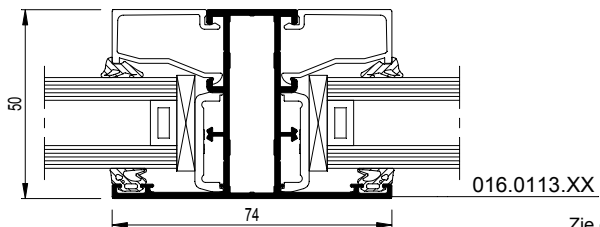

Zie ook T-profielen op blz. 12-13  
Voir aussi traverses page 12-13  
See also transom-mullions on pages 12-13  
Siehe auch Sprossen Seite 12-13

CS59Pa-009003.dxf  
CS59Pa-009003.dwg

9

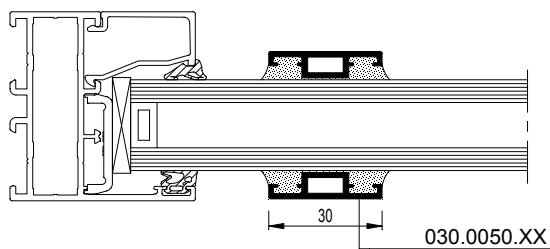

CS59Pa-009002.dxf  
CS59Pa-009002.dwg

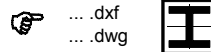
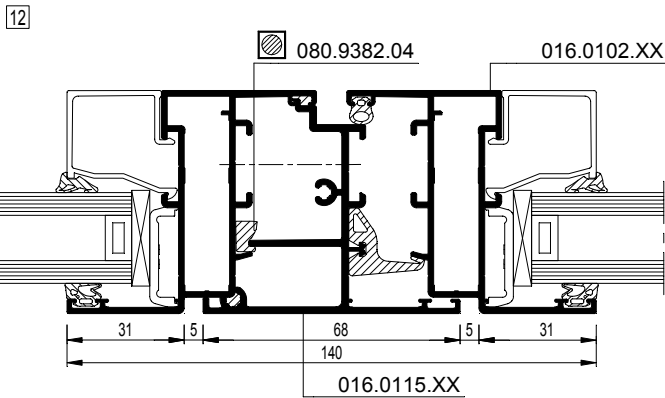
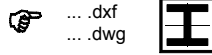
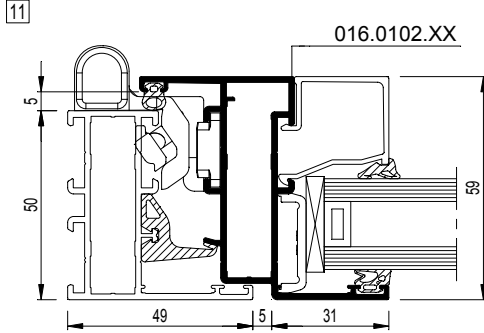
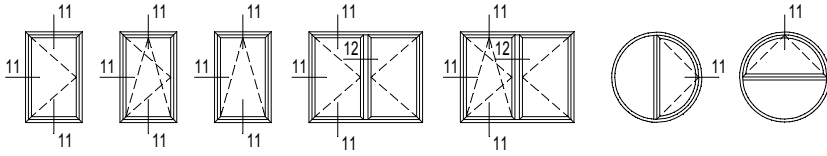

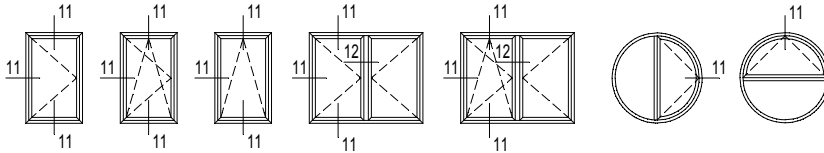

## 016.0102.XX

lx = 16.445 cm<sup>4</sup>

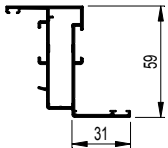

CS59Pa-011001.dxf  
 CS59Pa-011001.dwg

11

CS59Pa-012001.dxf  
 CS59Pa-012001.dwg

12

## 016.0192.XX

lx = 20.858 cm<sup>4</sup>

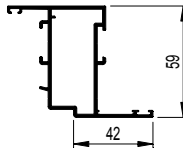

CS59Pa-011002.dxf  
 CS59Pa-011002.dwg

11

CS59Pa-012002.dxf  
 CS59Pa-012002.dwg

12

## 016.0121.XX

lx = 27.002 cm<sup>4</sup>

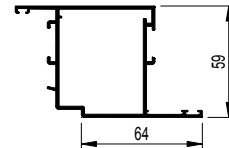

CS59Pa-011003.dxf  
 CS59Pa-011003.dwg

11

CS59Pa-012003.dxf  
 CS59Pa-012003.dwg

12

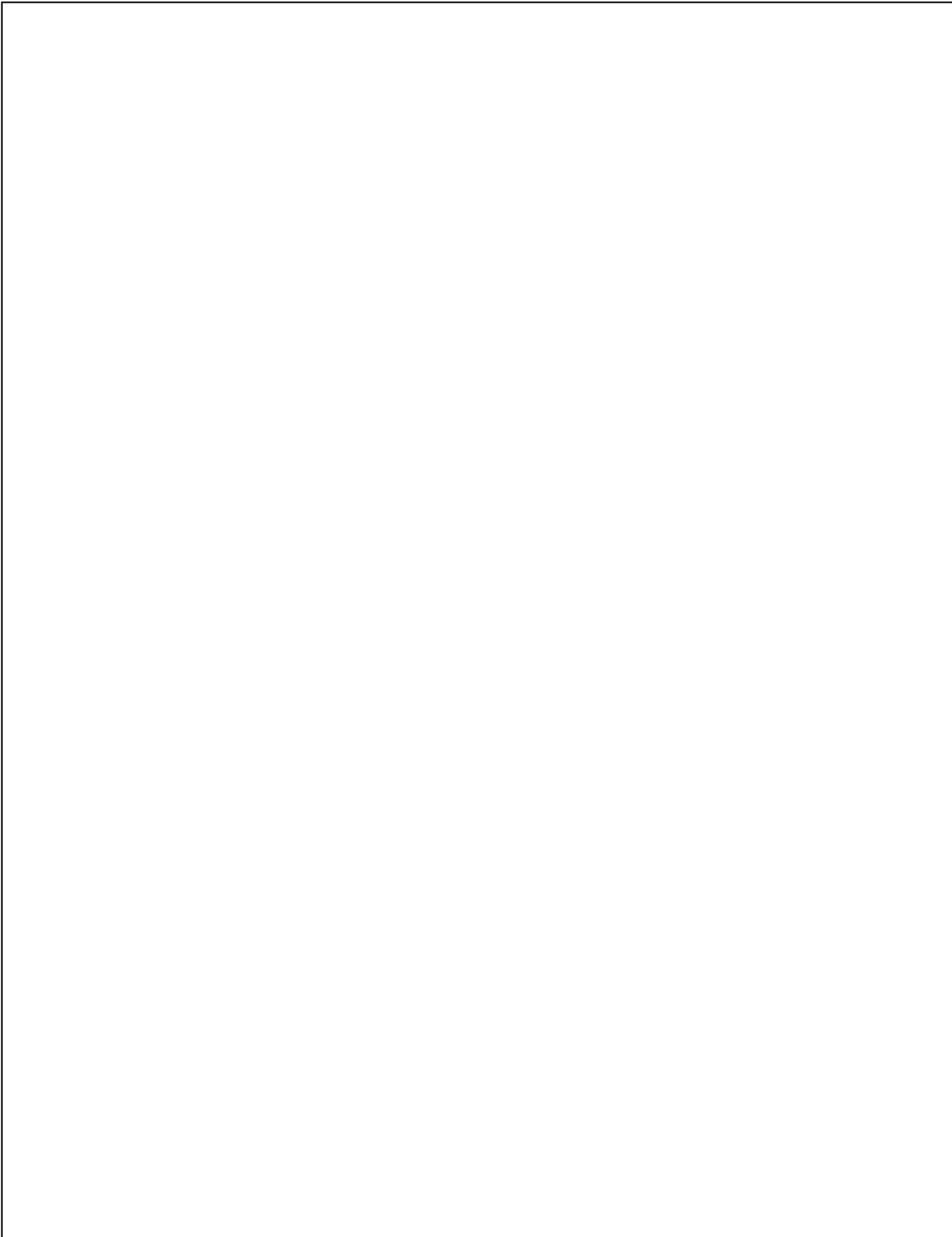

# CS 59Pa

Opengaande elementen - Naar buiten opengaande ramen  
 Éléments ouvrants - Fenêtre ouvrant vers l'extérieur  
 Opening elements - Outward opening windows  
 Öffnende Elemente - Nach außen öffnende Fenster

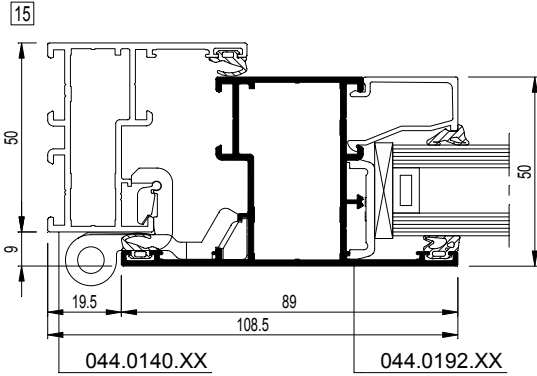
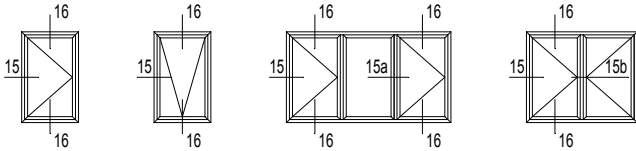

044.0102.XX

$I_x = 12.894 \text{ cm}^4$

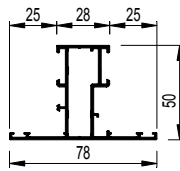

15 CS59Pa-015001.dxf  
 CS59Pa-015001.dwg

16 CS59Pa-016001.dxf  
 CS59Pa-016001.dwg

044.0192.XX

$I_x = 14.884 \text{ cm}^4$

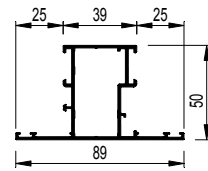

15 CS59Pa-015002.dxf  
 CS59Pa-015002.dwg

16 CS59Pa-016002.dxf  
 CS59Pa-016002.dwg

... .dxf  
 ... .dwg

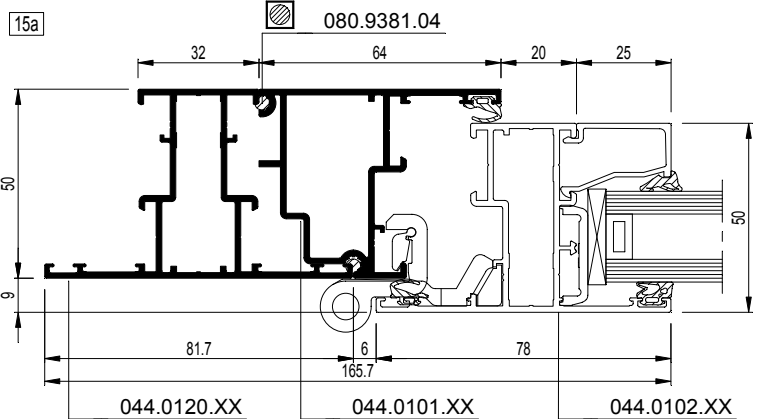
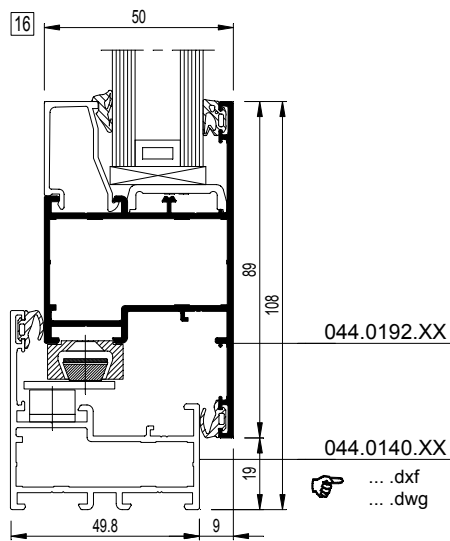

CS59Pa-015005.dxf  
 CS59Pa-015005.dwg

044.0140.XX  
 ... .dxf  
 ... .dwg

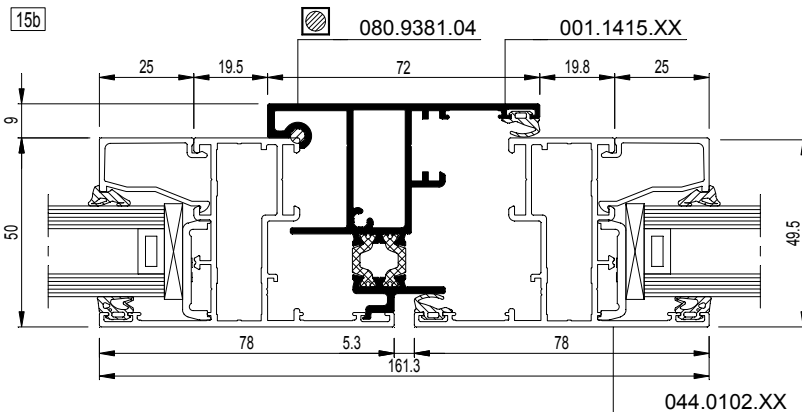

CS59Pa-015006.dxf  
 CS59Pa-015006.dwg

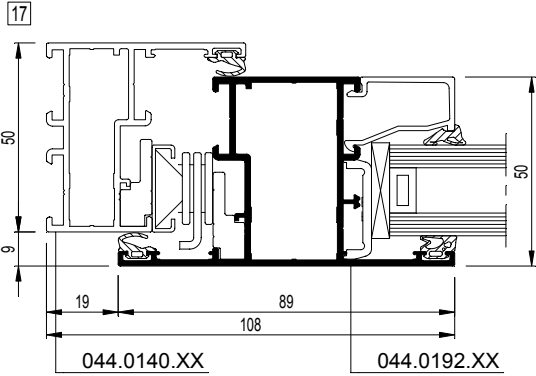
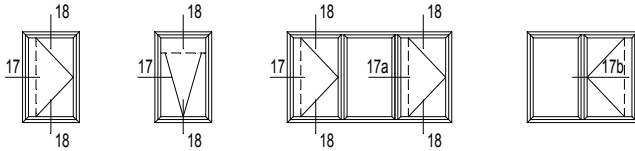

044.0102.XX

$I_x = 12.894 \text{ cm}^4$

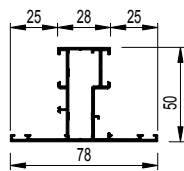

17 CS59Pa-017001.dxf  
 CS59Pa-017001.dwg

18 CS59Pa-018001.dxf  
 CS59Pa-018001.dwg

044.0192.XX

$I_x = 14.884 \text{ cm}^4$

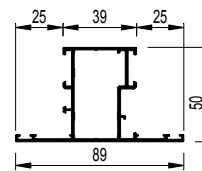

17 CS59Pa-017002.dxf  
 CS59Pa-017002.dwg

18 CS59Pa-018002.dxf  
 CS59Pa-018002.dwg

... .dxf  
 ... .dwg

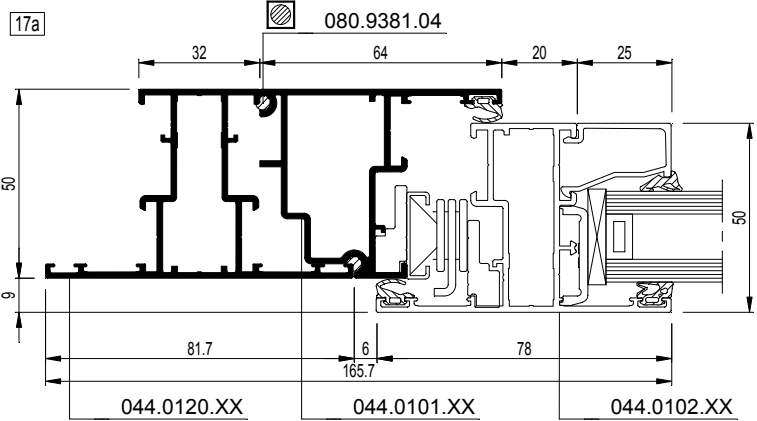
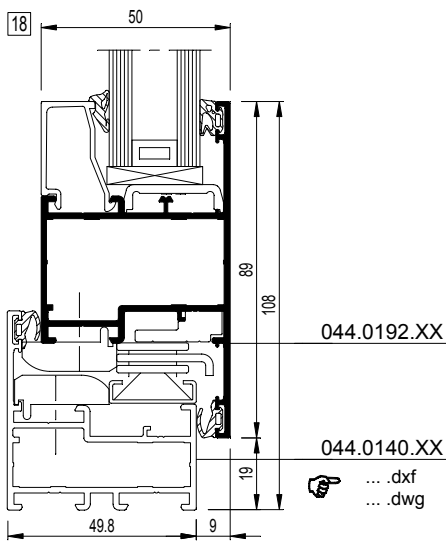

CS59Pa-015005.dxf  
 CS59Pa-015005.dwg

... .dxf  
 ... .dwg

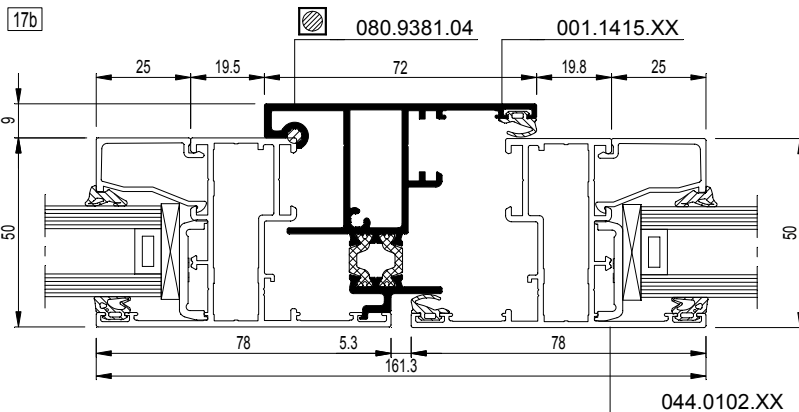

CS59Pa-015006.dxf  
 CS59Pa-015006.dwg



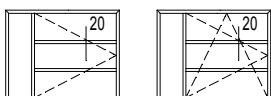

20

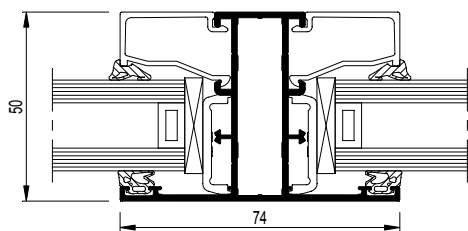

☞ Zie ook T-profielen op blz. 22-23  
Voir aussi traverses page 22-23  
See also transom-mullions on pages 22-23  
Siehe auch Sprossen Seite 22-23

CS59Pa-020001.dxf  
CS59Pa-020001.dwg

20

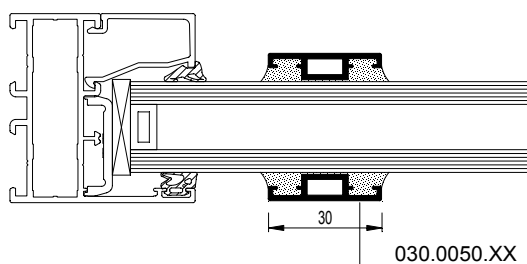

CS59Pa-020002.dxf  
CS59Pa-020002.dwg

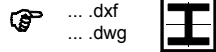
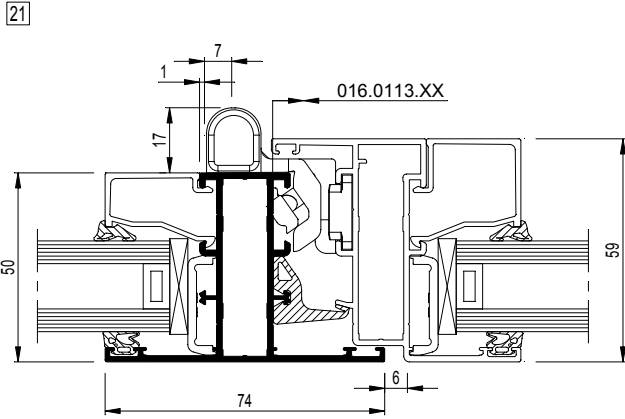
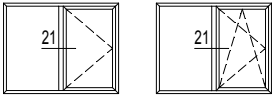

## 016.0113.XX

$I_x = 11.786 \text{ cm}^4$

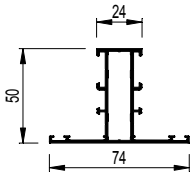

**21** CS59Pa-021001.dxf  
 CS59Pa-021001.dwg

## 016.0120.XX

$I_x = 14.610 \text{ cm}^4$

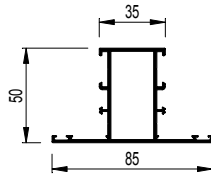

**21** CS59Pa-021002.dxf  
 CS59Pa-021002.dwg

## 016.0114.XX

$I_x = 16.886 \text{ cm}^4$

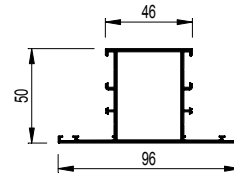

**21** CS59Pa-021003.dxf  
 CS59Pa-021003.dwg

## 016.0813.XX

$I_x = 13.054 \text{ cm}^4$

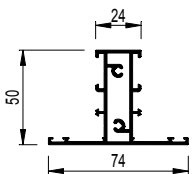

**21** CS59Pa-021004.dxf  
 CS59Pa-021004.dwg

## 016.0820.XX

$I_x = 15.700 \text{ cm}^4$

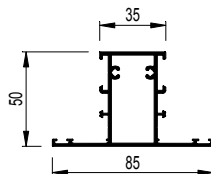

**21** CS59Pa-021005.dxf  
 CS59Pa-021005.dwg

## 016.0814.XX

$I_x = 17.934 \text{ cm}^4$

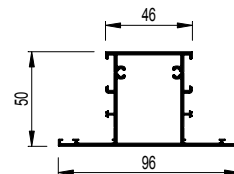

**21** CS59Pa-021006.dxf  
 CS59Pa-021006.dwg

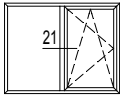
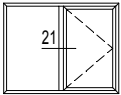

016.0817.XX

$I_x = 33.870 \text{ cm}^4$

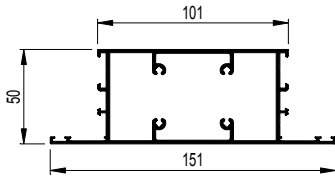

CS59Pa-021007.dxf  
CS59Pa-021007.dwg

016.0847.XX

$I_x = 36.435 \text{ cm}^4$

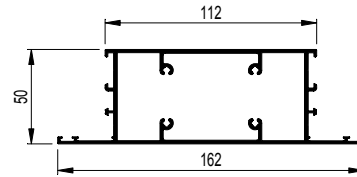

CS59Pa-021008.dxf  
CS59Pa-021008.dwg

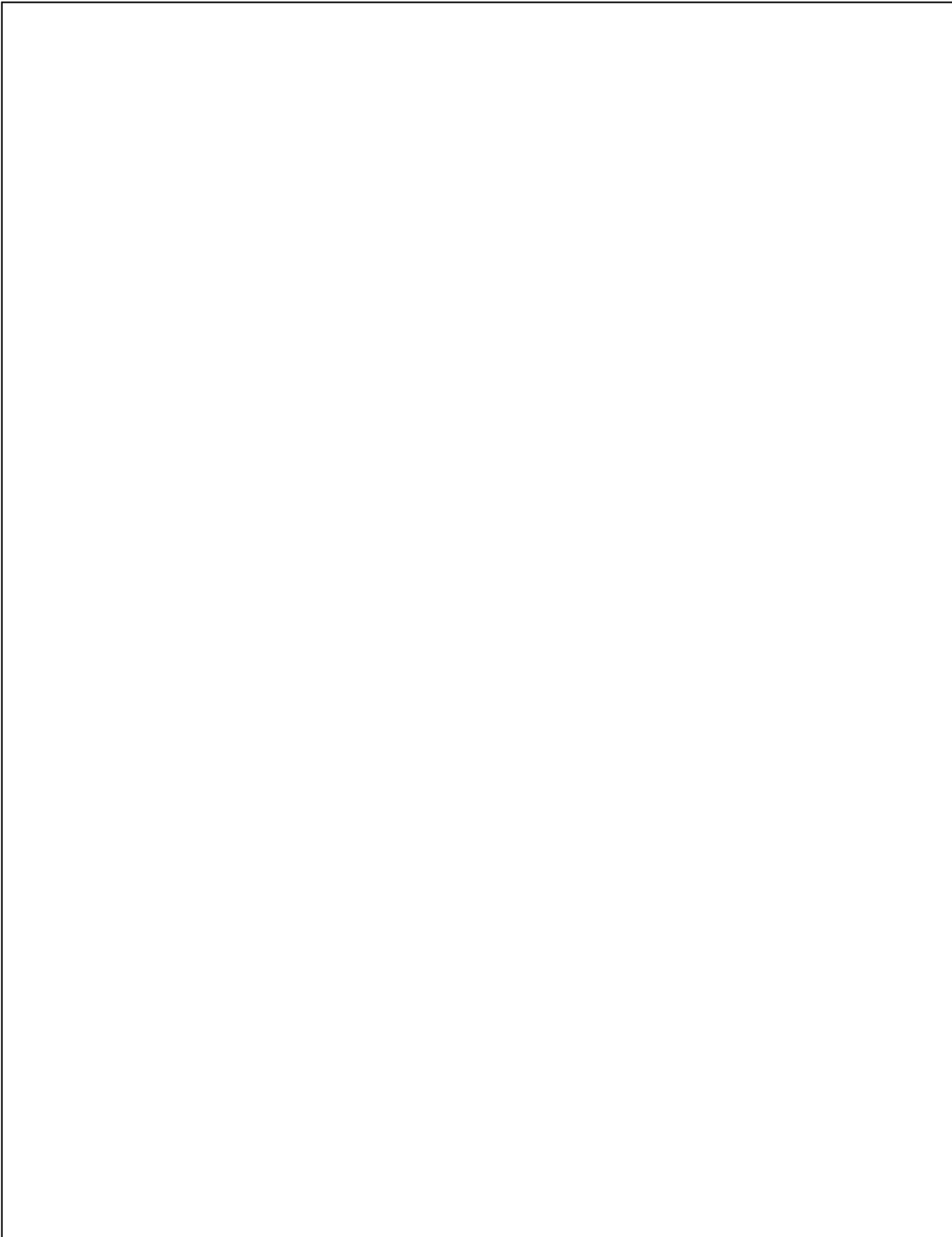

# CS 59Pa

Samengestelde elementen - T-Profiel versterkt  
Éléments composés - Traverse renforcée  
Composed elements - Transom-mullion reinforced  
Kombinierte Elemente - Sprosse verstärkt

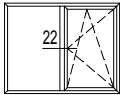
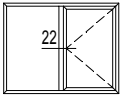

22

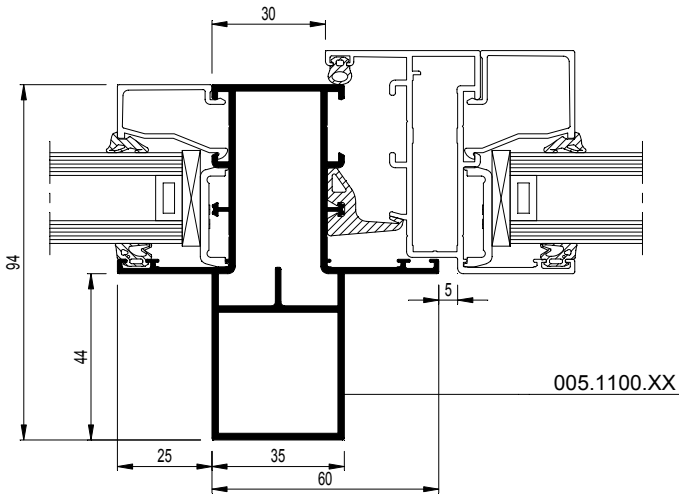

005.1100.XX

CS59Pa-022001.dxf  
CS59Pa-022001.dwg

Eindstukken beschikbaar  
Pièces finales disponibles  
End caps available  
Endstücke verfügbar

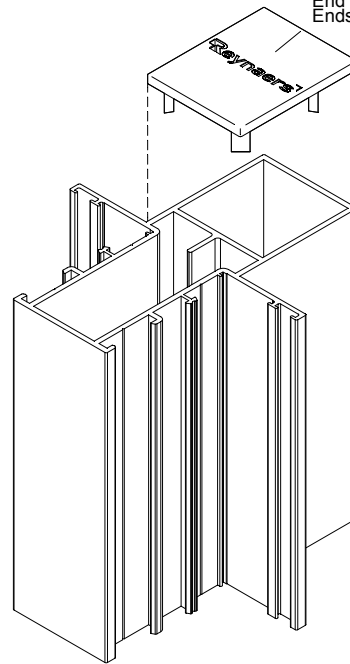

CS59Pa-3d0002.dxf  
CS59Pa-3d0002.dwg

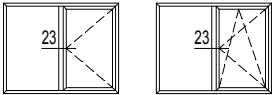

23a

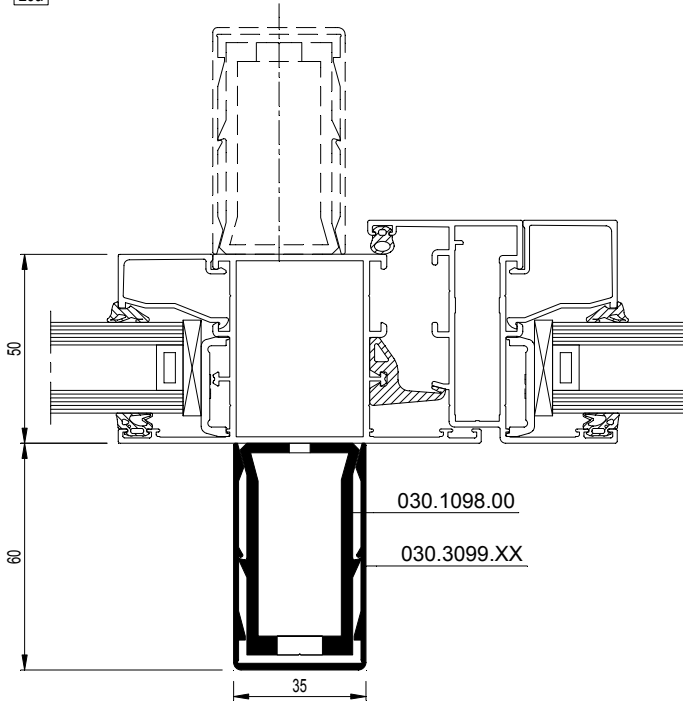

23

Nota : voor keuze van versteviging : zie waarden op blz 18-19  
 Note : pour choix de renforcement : voir valeurs page 18-19  
 Note : For choice of reinforcement, see values on pages 18-19  
 Note : für Verstärkungswahl : siehe Werte Seite 18-19

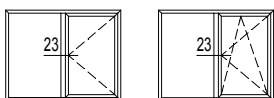

030.1098.00

$I_x = 19.656 \text{ cm}^4$



23

CS59Pa-023003.dxf  
 CS59Pa-023003.dwg

030.3099.XX

$I_x = 9.625 \text{ cm}^4$

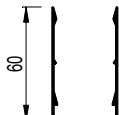

030.1097.00

$I_x = 10.260 \text{ cm}^4$



23

CS59Pa-023004.dxf  
 CS59Pa-023004.dwg

030.3099.XX

$I_x = 9.625 \text{ cm}^4$

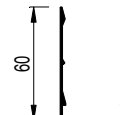

030.1096.00

$I_x = 4.881 \text{ cm}^4$



23

CS59Pa-023005.dxf  
 CS59Pa-023005.dwg

030.3097.XX

$I_x = 2.767 \text{ cm}^4$



Opmerking: - Versteviging van binnenzijde + scharnier is niet mogelijk indien de binnenzijde van een T-profiel < 75 mm

- Bevestiging: om de 300 mm
- Bij horizontale versteviging, contacteer Reynaers Consult



Remarque: - Positionnement du renfort à l'intérieur en présence de charnières non possible sur profilé-T de largeur intérieure < 75 mm

- Fixation: tous les 300 mm
- Pour utilisation comme renfort horizontal, contactez Reynaers Consult

Remark: - Reinforcement of inner side + hinge is not possible in case the inner side of a transom-mullion < 75 mm Fixing: every 300 mm

- For horizontal reinforcements, please contact Reynaers Consult - tel. 015/30 88 99

Anmerkung: - Verstärkung der Innenseite und Band ist unmöglich wenn die Innenseite einer Sprosse < 75 mm

- Bevestiging: jede 300 mm
- Bei horizontaler Verstärkung, bitte nehmen Sie Kontakt auf mit Reynaers Consult

		i Versteviging langs binnen Renforcement du côté intérieur Reinforcement inside Verstärkung der Innenseite		e Versteviging langs buiten Renforcement du côté extérieur Reinforcement outside Verstärkung der Aussenseite			
T-profiel Traverse Transom-mullion Sprosse	Zonder versteviging Sans renforcement Without reinforcement Ohne Verstärkung	met avec with mit	030.1097.00	met avec with mit	030.1098.00		
	Ix cm4	Wx cm3		Ix cm4	Wx cm3	Ix cm4	Wx cm3
016.0113.XX 	11.786	3.797	e	49.41	9.51	74.92	12.44
016.0120.XX 	14.610	4.834	e	55.16	10.38	83.16	14.31
			i	72.27	12.26	107.10	20.05
016.0114.XX 	16.886	5.668	e	61.71	10.96	88.66	15.61
			i	75.40	12.59	111.67	20.80



Opmerking: - Versteving van binnenzijde + scharnier is niet mogelijk indien de binnenzijde van een T-profiel  $< 75$  mm is  
- Bevestiging: om de 300 mm  
- Bij horizontale versteving, contacteer Reynaers Consult



Remarque: - Positionnement du renfort à l'intérieur en présence de charnières non possible sur profilé-T de largeur intérieure  $< 75$  mm  
- Fixation: tous les 300 mm  
- Pour utilisation comme renfort horizontal, contactez Reynaers Consult

Remark: - Reinforcement of inner side + hinge is not possible in case the inner side of a transom-mullion  $< 75$  mm  
- For horizontal reinforcements, please contact Reynaers Consult - tel. 015/30 88 99

Anmerkung: - Verstärkung der Innenseite und Band ist unmöglich wenn die Innenseite einer Sprosse  $< 75$  mm  
- Bevestigung: jede 300 mm  
- Bei horizontaler Verstärkung, bitte nehmen Sie Kontakt auf mit Reynaers Consult

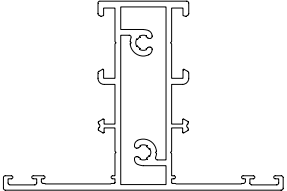
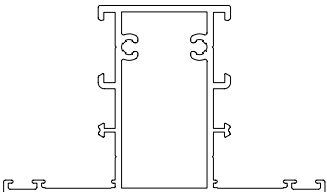
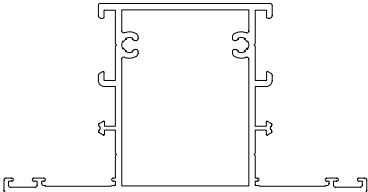
 T-profiel Sprosse Transom-mullion Traverse	Zonder versteving Sans renforcement Without reinforcement Ohne Verstärkung			met 030.1097.XX avec with mit		met 030.1098.XX avec with mit	
	lx cm4	Wx cm3	e	lx cm4	Wx cm3	lx cm4	Wx cm3
016.0813.XX  	13.054	4.298	e  i	53.32	10.09	81.00	13.88
016.0820.XX  	15.700	5.437	e  i	59.26  72.36	10.83  12.23	89.20  107.69	15.77  20.30
016.0814.XX  	17.934	6.276	e  i	62.97  75.46	11.29  12.57	94.39  112.18	17.05  20.73

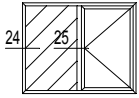

24

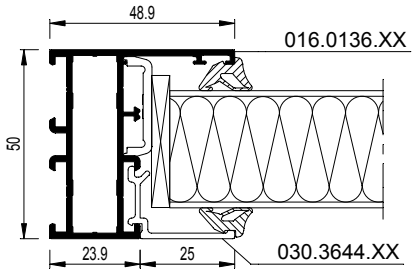

☞ ... .dxf  
 ... .dwg



25

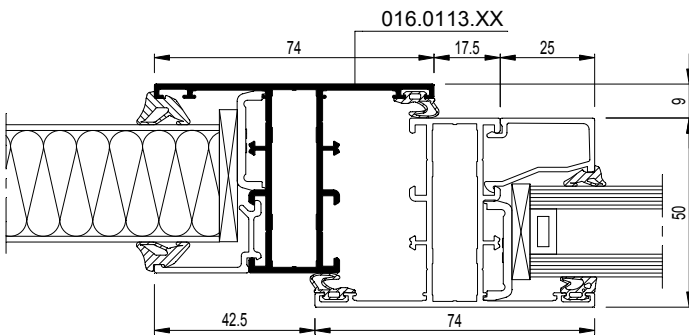

☞ ... .dxf  
 ... .dwg



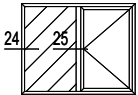

## 016.0136.XX

$I_x = 10.135 \text{ cm}^4$

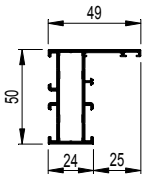

 CS59Pa-024001.dxf  
 CS59Pa-024001.dwg

## 016.0183.XX

$I_x = 12.836 \text{ cm}^4$

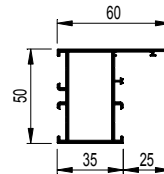

 CS59Pa-024002.dxf  
 CS59Pa-024002.dwg

## 016.0125.XX

$I_x = 15.047 \text{ cm}^4$

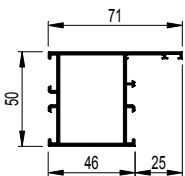

 CS59Pa-024003.dxf  
 CS59Pa-024003.dwg

## 016.0113.XX

$I_x = 11.786 \text{ cm}^4$

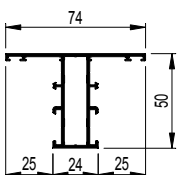

 CS59Pa-025001.dxf  
 CS59Pa-025001.dwg

## 016.0120.XX

$I_x = 14.610 \text{ cm}^4$

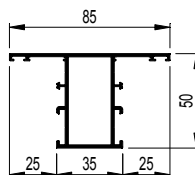

 CS59Pa-025002.dxf  
 CS59Pa-025002.dwg

## 016.0114.XX

$I_x = 16.886 \text{ cm}^4$

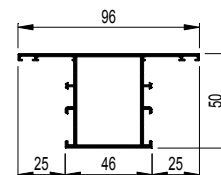

 CS59Pa-025003.dxf  
 CS59Pa-025003.dwg

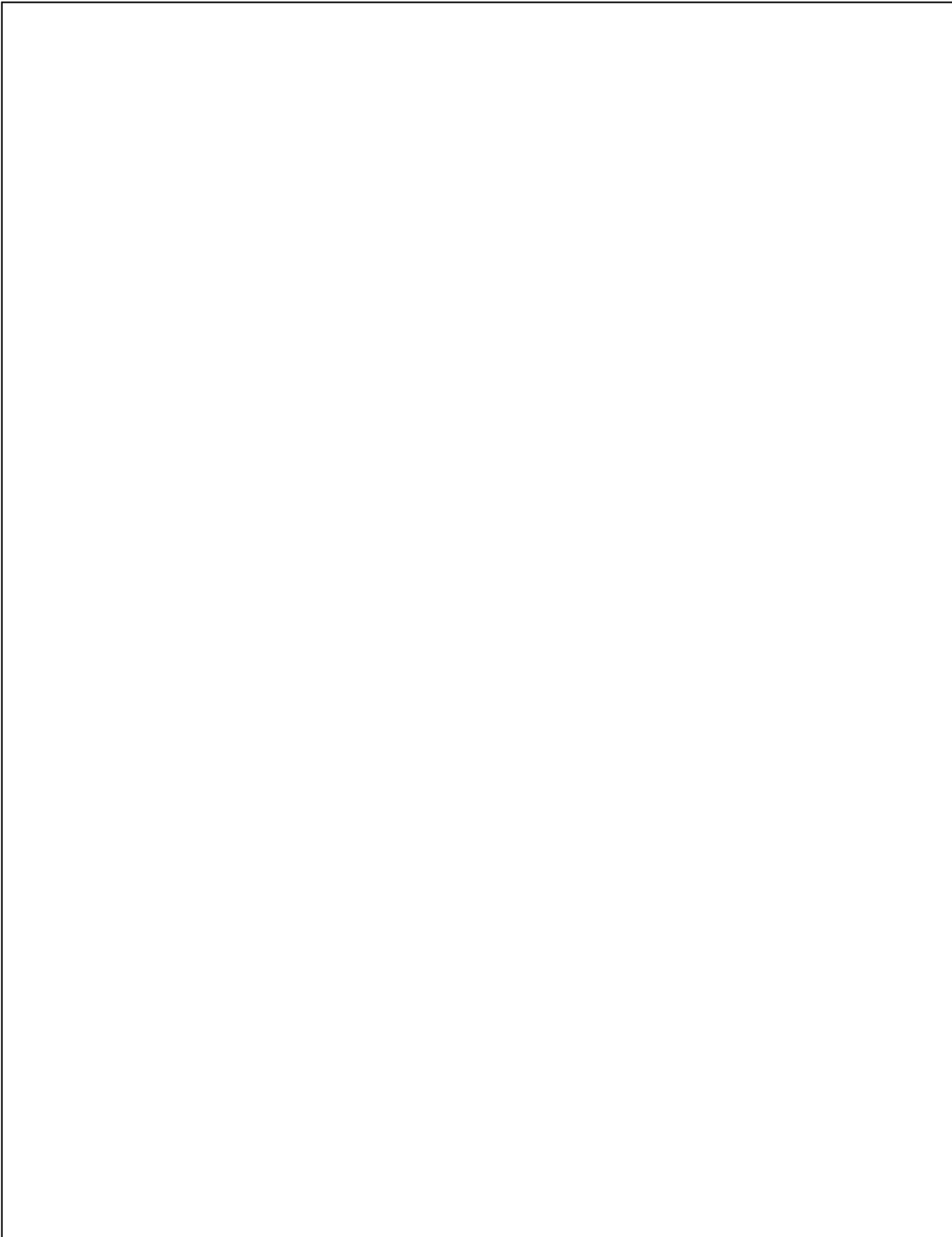

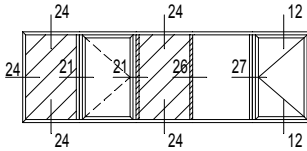

26

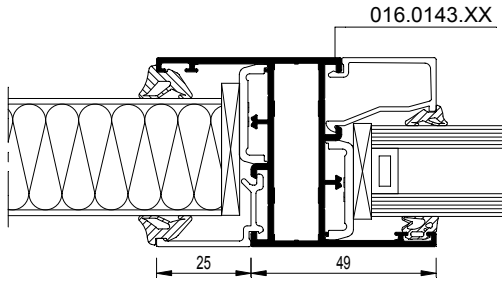

... .dxf  
 ... .dwg



27

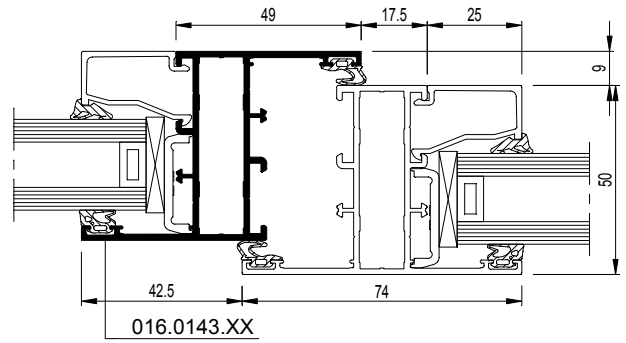

... .dxf  
 ... .dwg



## 016.0143.XX

$I_x = 13.090 \text{ cm}^4$

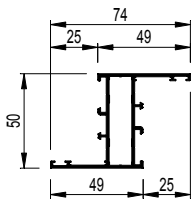

- 26 CS59Pa-026001.dxf  
CS59Pa-026001.dwg
- 27 CS59Pa-027001.dxf  
CS59Pa-027001.dwg

## 016.0105.XX

$I_x = 7.021 \text{ cm}^4$

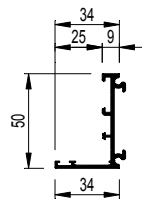

- 26 CS59Pa-026002.dxf  
CS59Pa-026002.dwg
- 27 CS59Pa-027002.dxf  
CS59Pa-027002.dwg

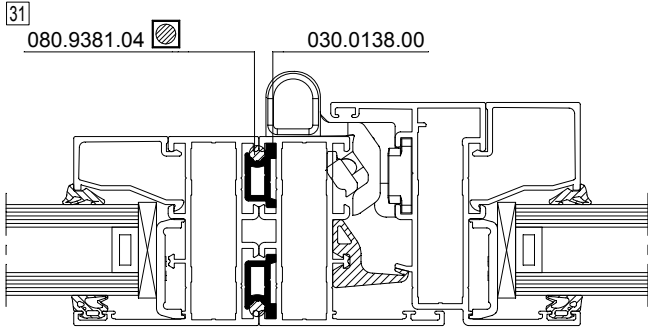
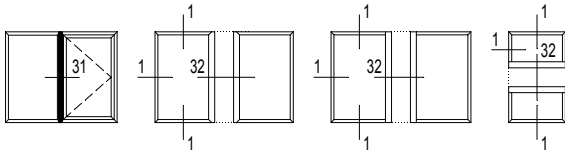

CS59Pa-031001.dxf  
 CS59Pa-031001.dwg

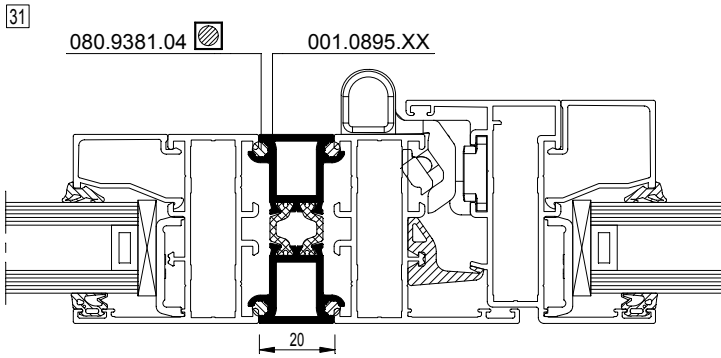

## 001.0895.XX

$I_x = 7.010 \text{ cm}^4$

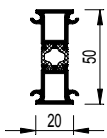

CS59Pa-031002.dxf  
 CS59Pa-031002.dwg

## 005.1848.XX

$I_x = 90.907 \text{ cm}^4$

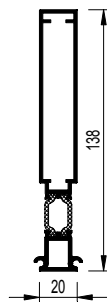

CS59Pa-031004.dxf  
 CS59Pa-031004.dwg

## 006.0371.XX

$I_x = 120.097 \text{ cm}^4$

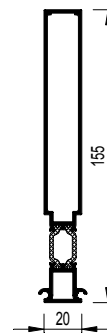

CS59Pa-031005.dxf  
 CS59Pa-031005.dwg

## 005.1837.XX

$I_x = 58.021 \text{ cm}^4$

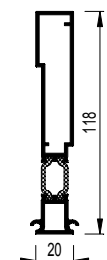

CS59Pa-031003.dxf  
 CS59Pa-031003.dwg

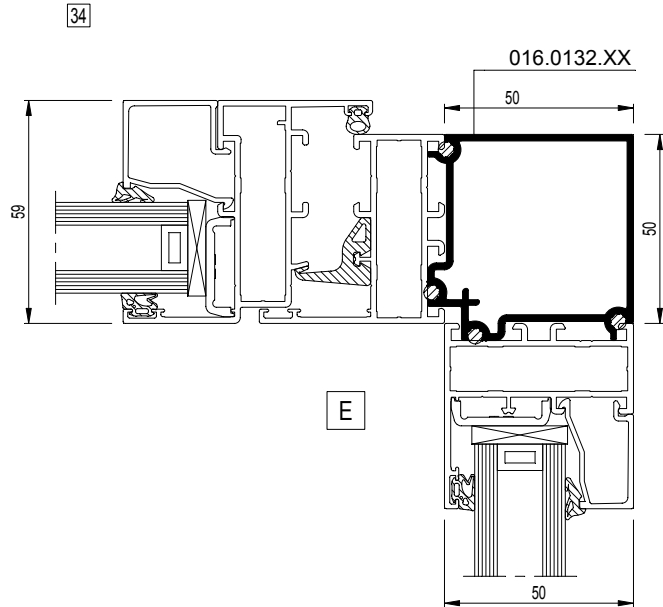
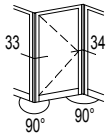

CS59Pa-034001.dxf  
 CS59Pa-034001.dwg

33

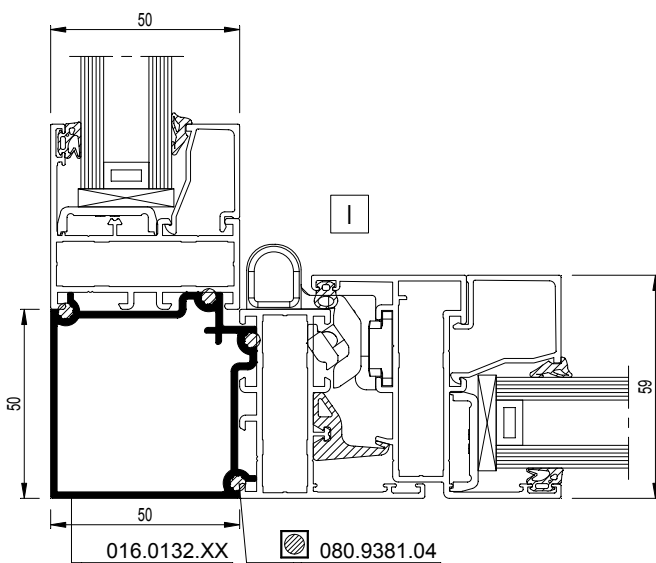

CS59Pa-033001.dxf  
 CS59Pa-033001.dwg

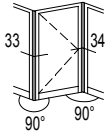

33

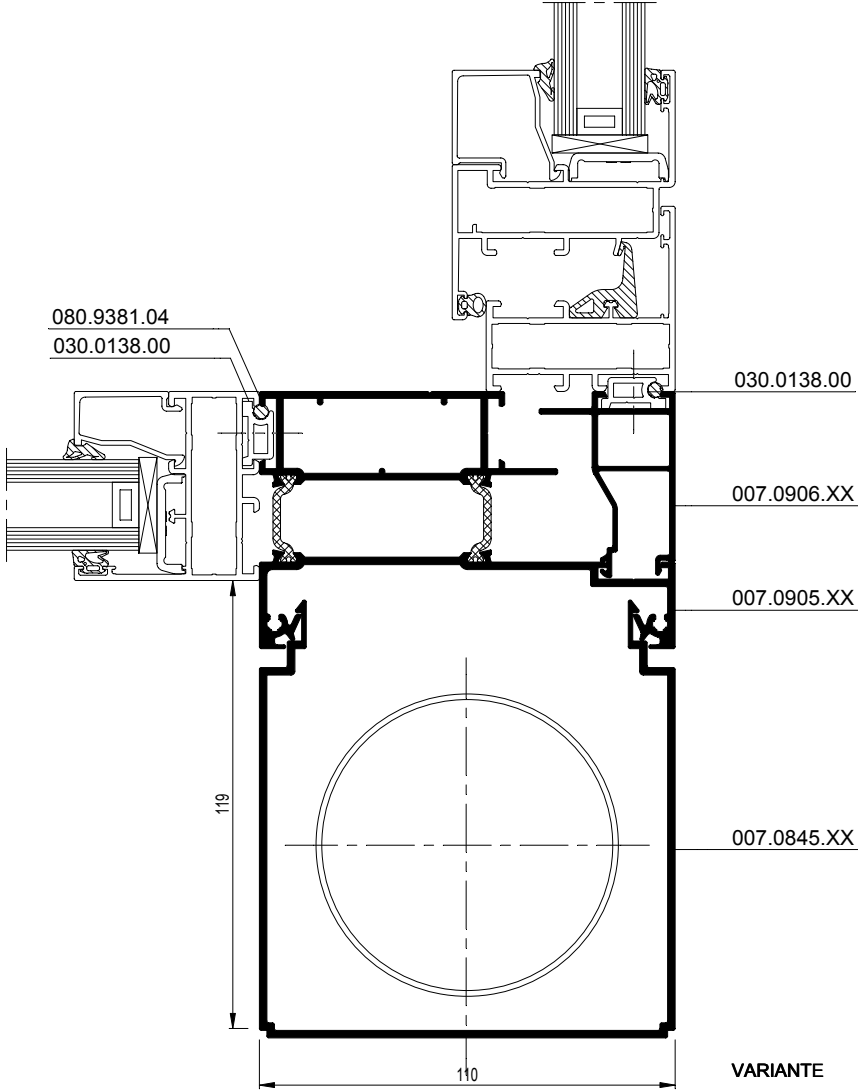

CS59Pa-033002.dxf  
 CS59Pa-033002.dwg



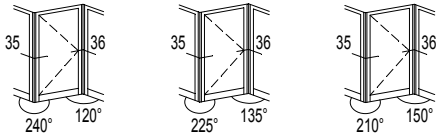

36

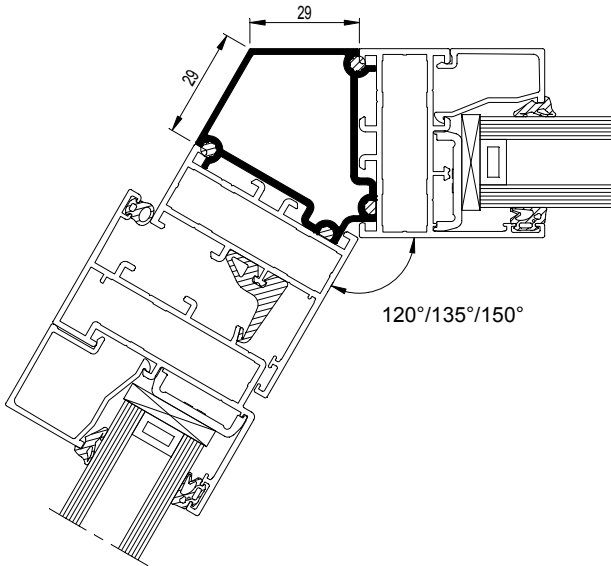

... .dxf  
 ... .dwg



35

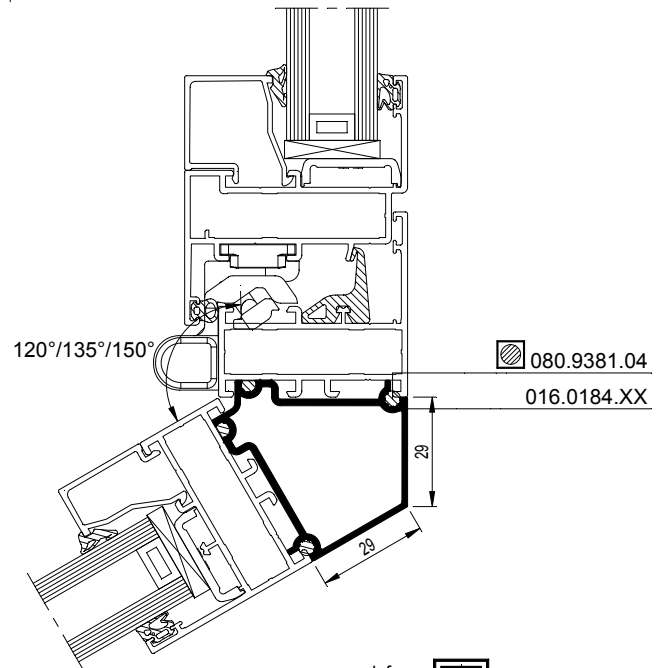

... .dxf  
 ... .dwg



016.0184.XX

$I_x = 7.785 \text{ cm}^4$

120°

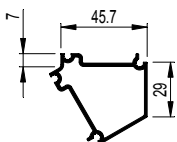

35 CS59Pa-035001.dxf  
 CS59Pa-035001.dwg

36 CS59Pa-036001.dxf  
 CS59Pa-036001.dwg

016.0178.XX

$I_x = 6.505 \text{ cm}^4$

135°

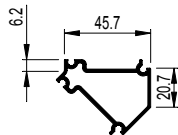

35 CS59Pa-035002.dxf  
 CS59Pa-035002.dwg

36 CS59Pa-036002.dxf  
 CS59Pa-036002.dwg

016.0179.XX

$I_x = 2.119 \text{ cm}^4$

150°

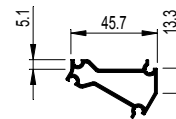

35 CS59Pa-035003.dxf  
 CS59Pa-035003.dwg

36 CS59Pa-036003.dxf  
 CS59Pa-036003.dwg

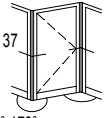

90°-170°

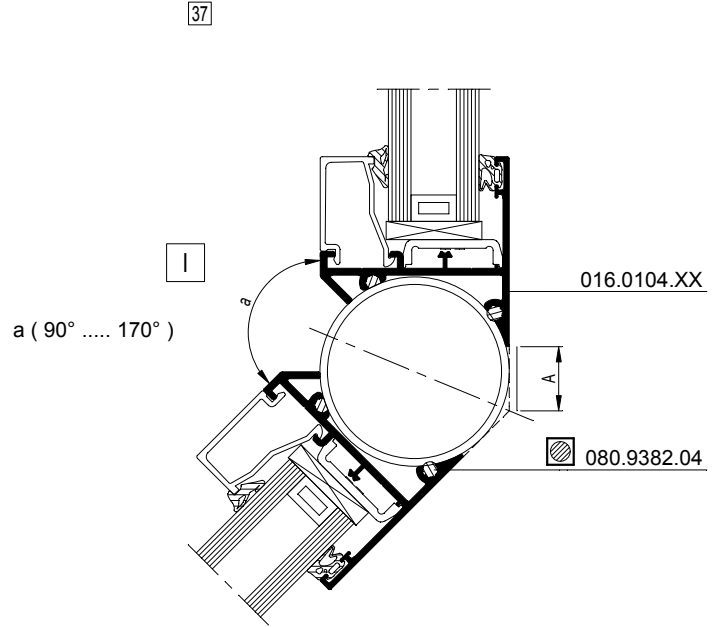

CS59Pa-037001.dxf  
 CS59Pa-037001.dwg

a	A
170°	8.8
160°	11
150°	13.3
140°	15.8
130°	18.3
120°	21.1
110°	24.2
100°	27.7
90°	31.7

## CS 59Pa (doors)



### 5 Doors inward opening

Inward opening doors

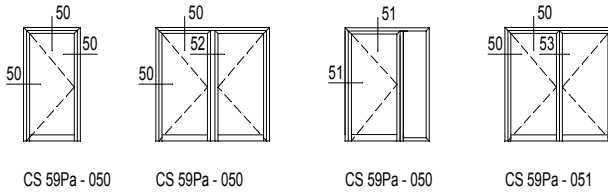

... with window profiles

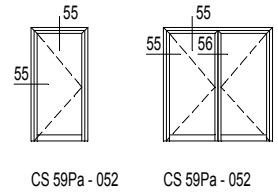

Inward opening doors with vent crimped all round

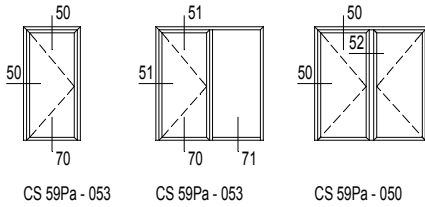

... with window profiles

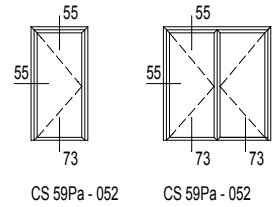

Doors with transom-mullion

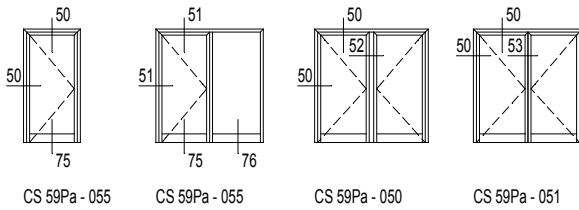

### 6 Doors outward opening

Outward opening doors

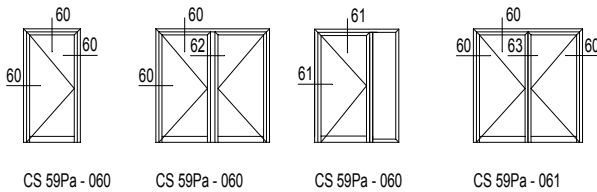

Outward opening doors with vent crimped all round

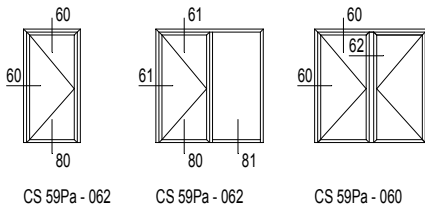

Doors with transom-mullion

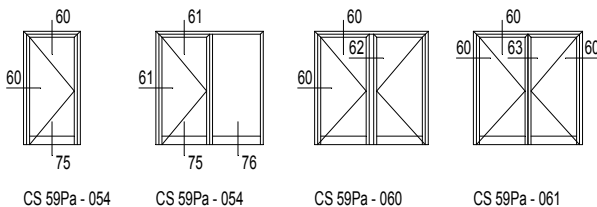

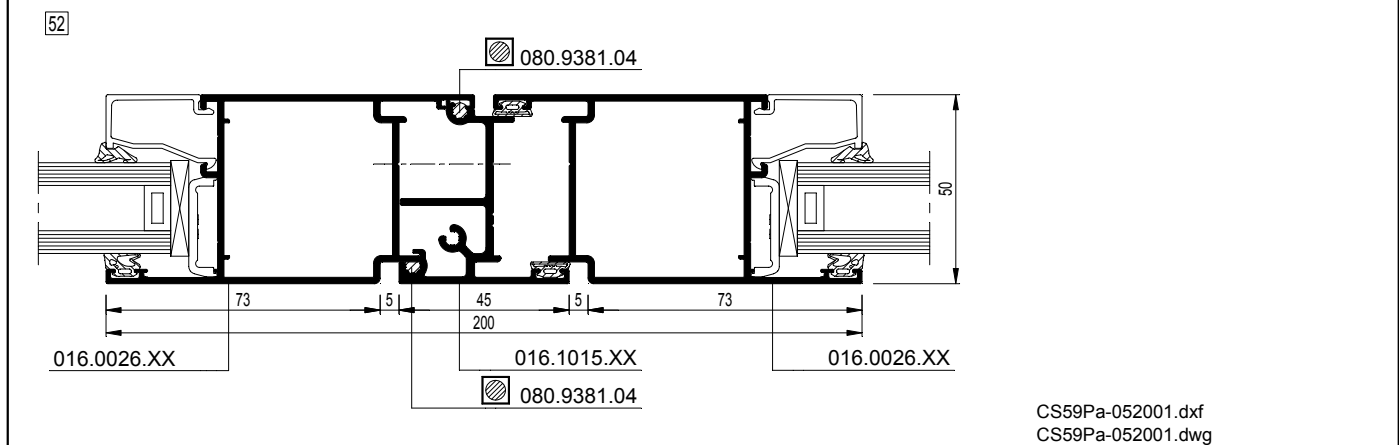
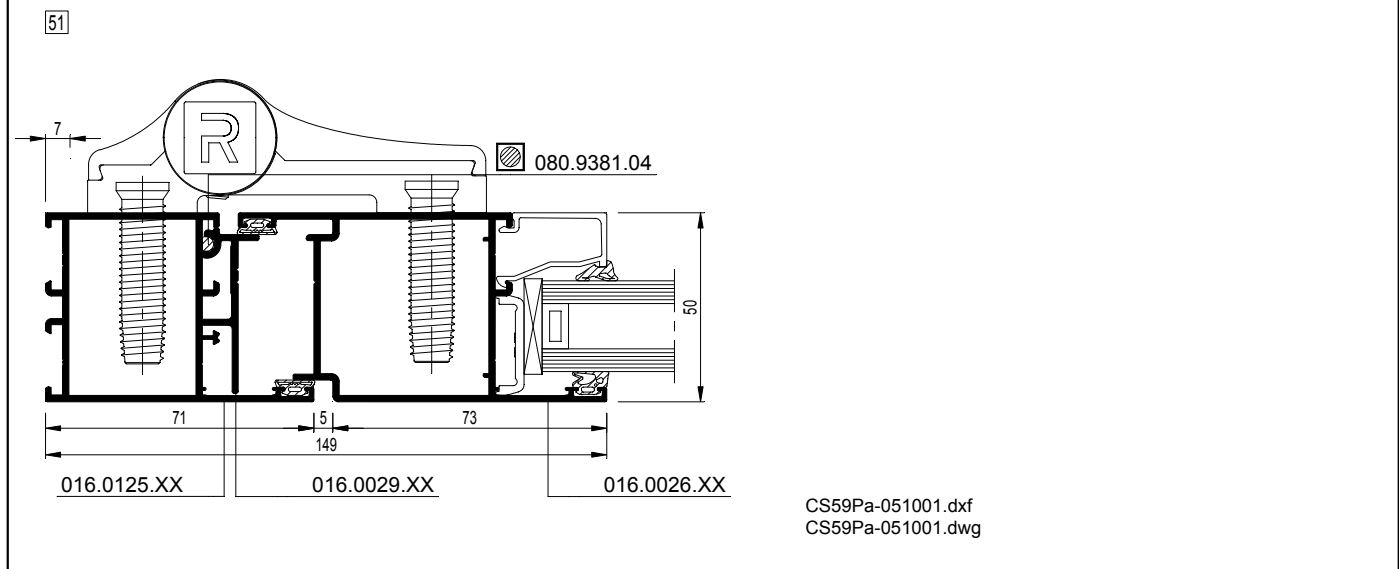
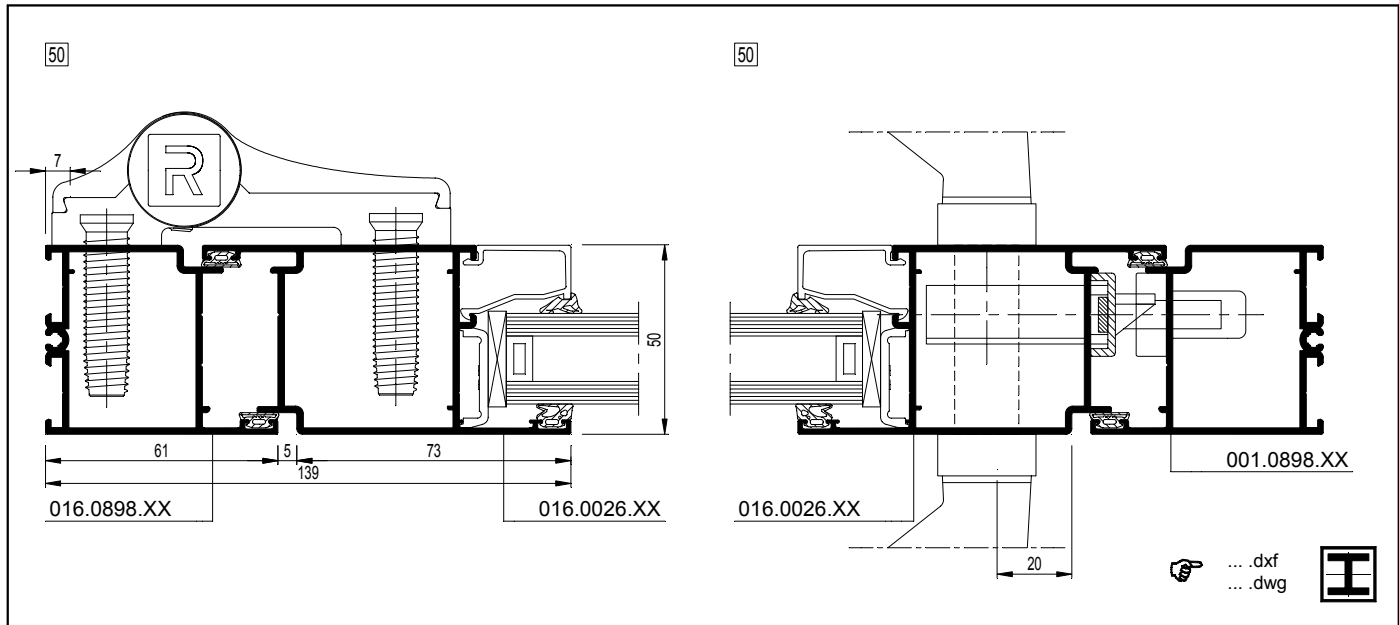
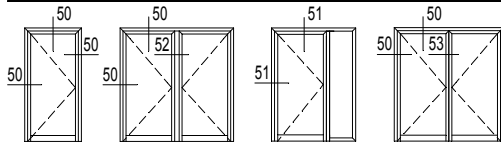

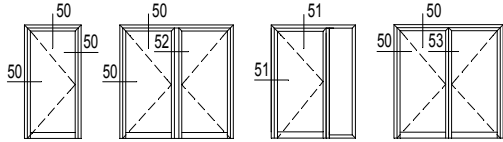

016.0898.XX

$I_x = 13.668 \text{ cm}^4$

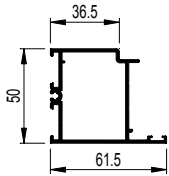

50 CS59Pa-050001.dxf  
 CS59Pa-050001.dwg

016.0014.XX

$I_x = 17.961 \text{ cm}^4$

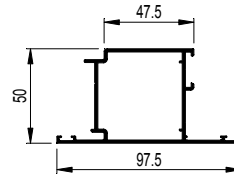

50 CS59Pa-050002.dxf  
 CS59Pa-050002.dwg

53 ZT

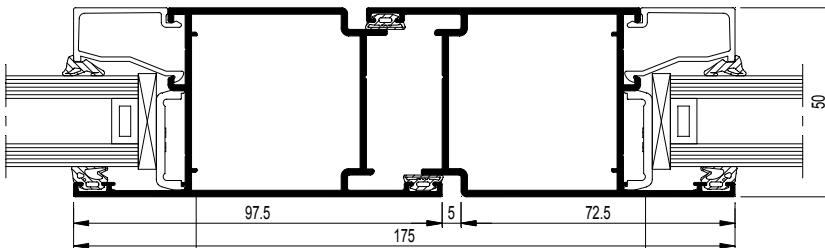

016.0014.XX

016.0026.XX

CS59Pa-053001.dxf  
 CS59Pa-053001.dwg

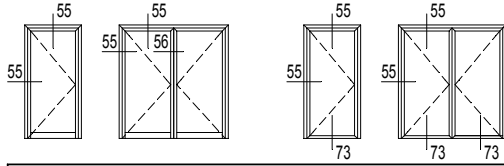

55

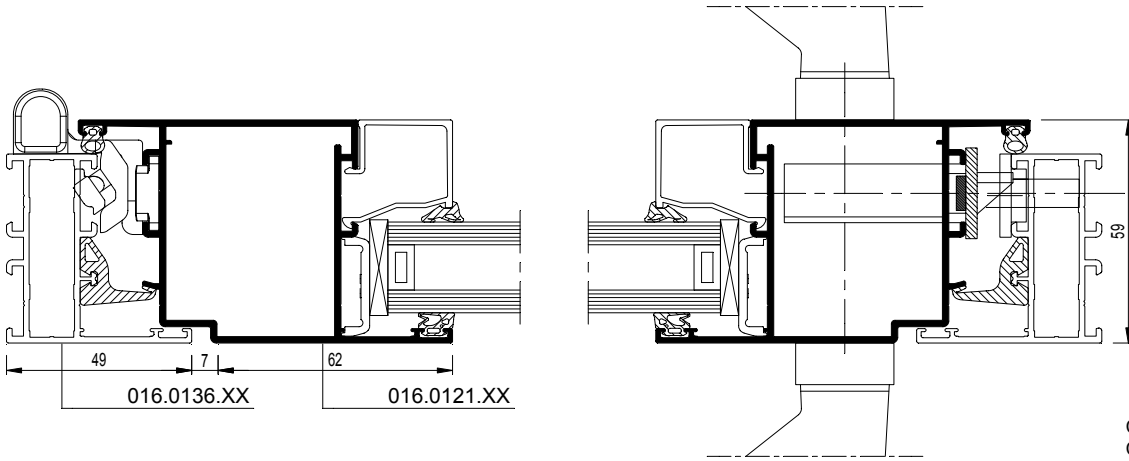

CS59Pa-055001.dxf  
 CS59Pa-055001.dwg

56

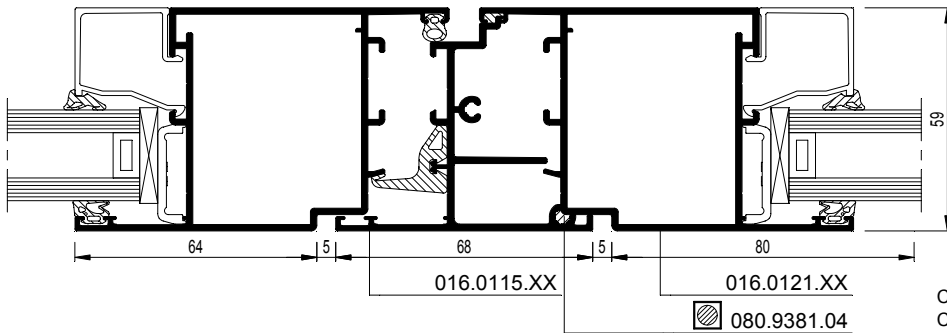

CS59Pa-056001.dxf  
 CS59Pa-056001.dwg

73

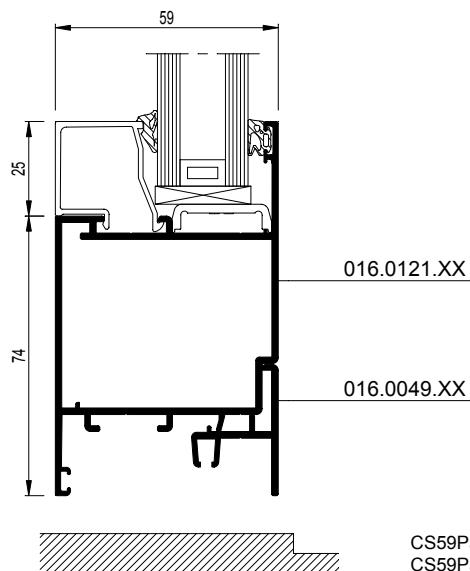

CS59Pa-073001.dxf  
 CS59Pa-073001.dwg

# CS 59Pa

Deuren - Naar binnen draaiende deuren met deurvleugel rondom geperst  
 Portes - Portes ouvrant vers l'intérieur avec ouvrant serti tout autour  
 Doors - Inward opening doors with vent crimped all round  
 Türen - Nach innen öffnende Türen mit rundherum gepresstem Türflügel

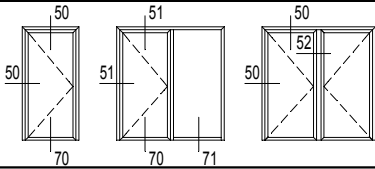

70

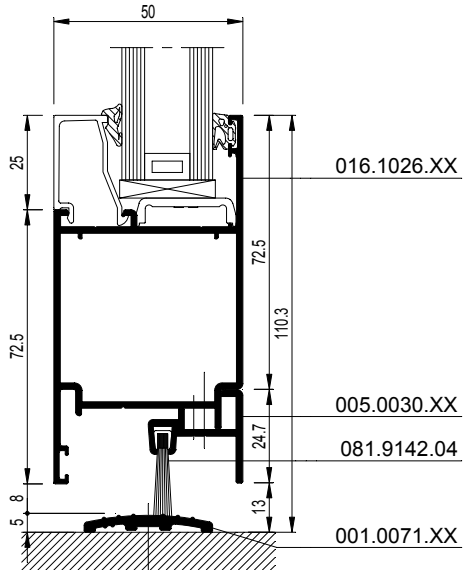

CS59Pa-070001.dxf  
 CS59Pa-070001.dwg

71

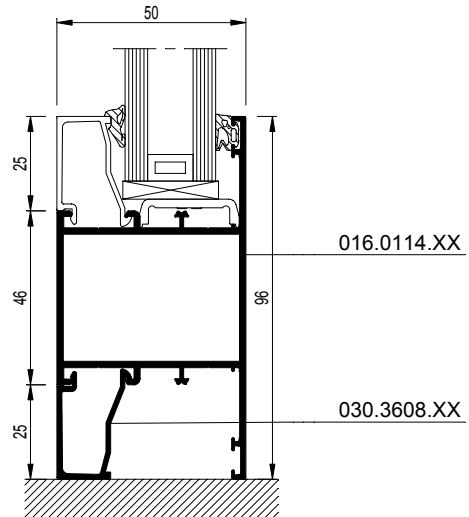

CS59Pa-071001.dxf  
 CS59Pa-071001.dwg

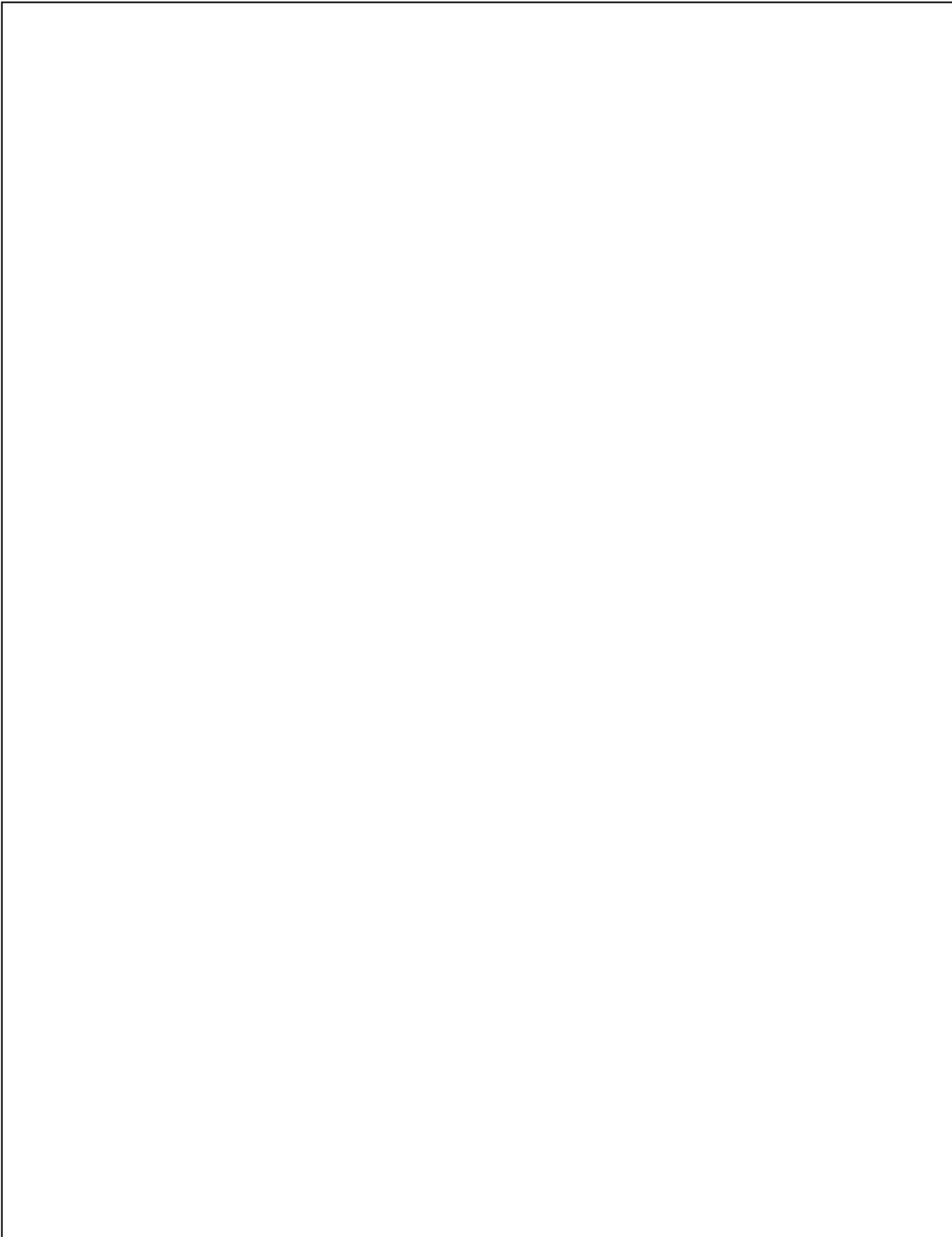



# CS 59Pa

Deuren naar binnen draaiend - Deuren met T-profiel  
 Portes ouvrant vers l'intérieur - Portes avec traverse  
 Doors inward opening - Doors with transom-mullion  
 Türen nach innen öffnend - Türen mit T-profilsockel

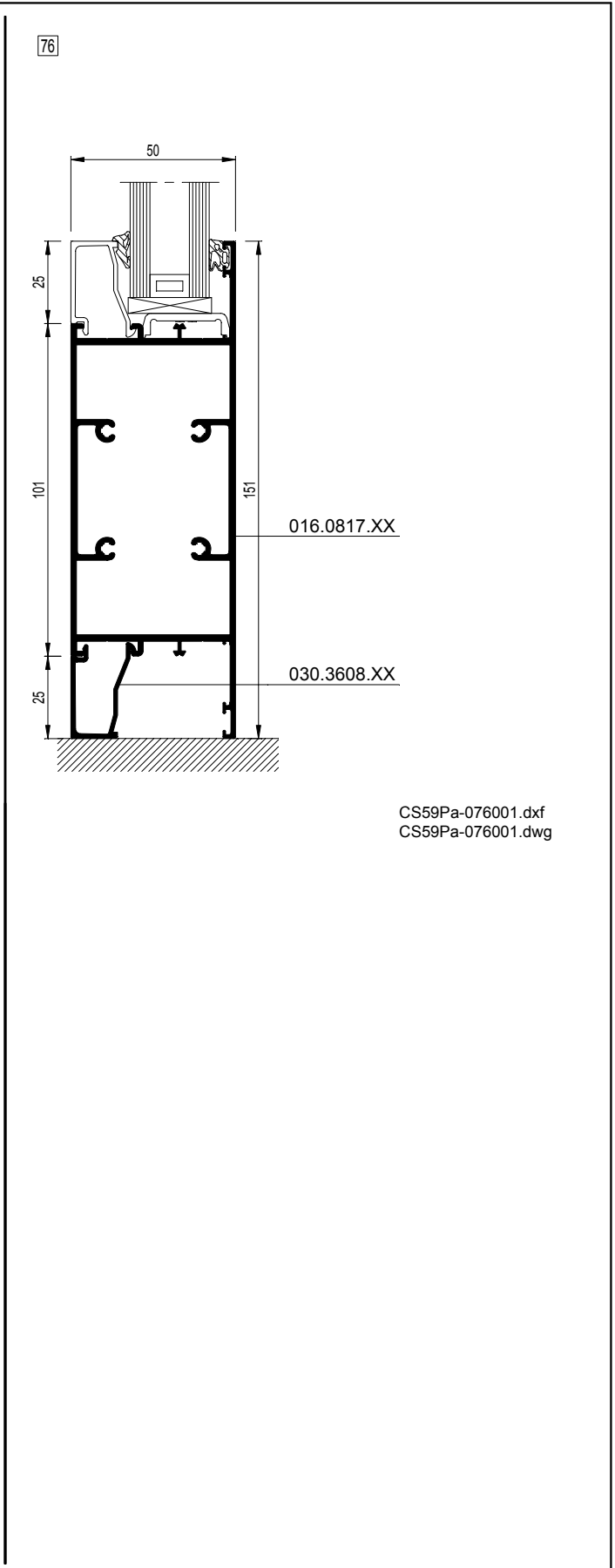
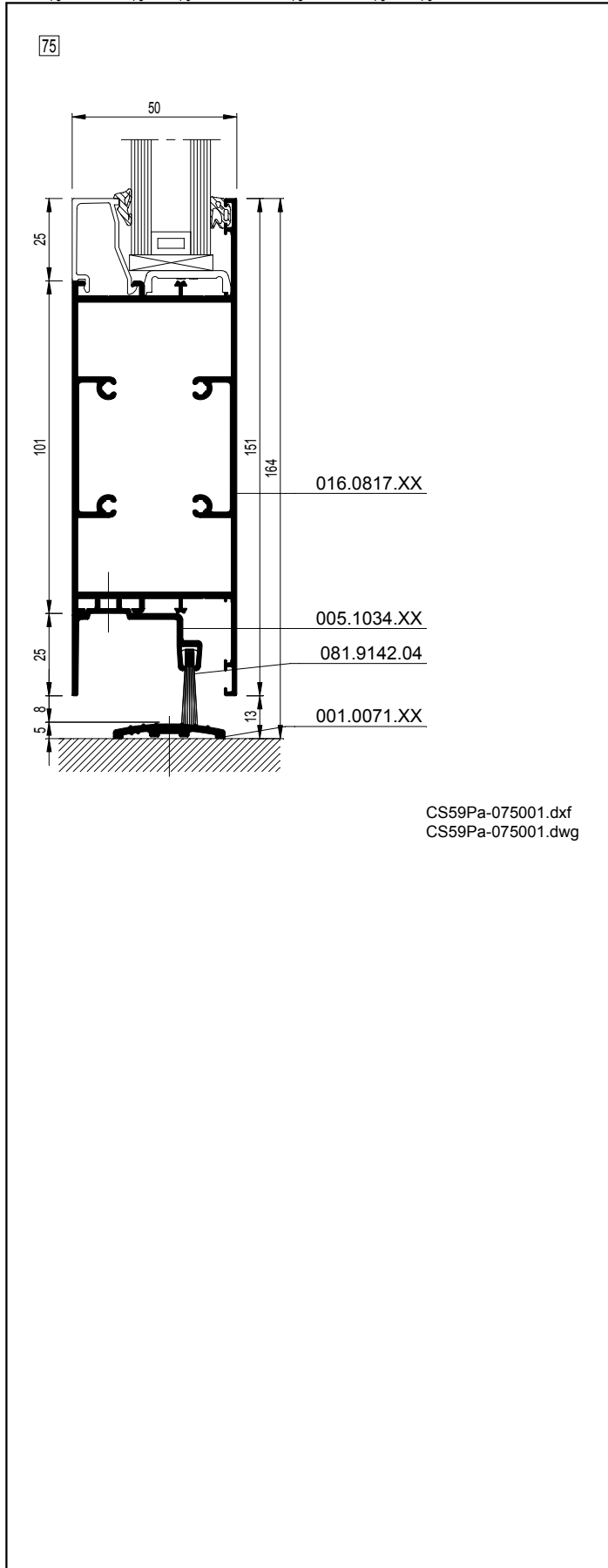
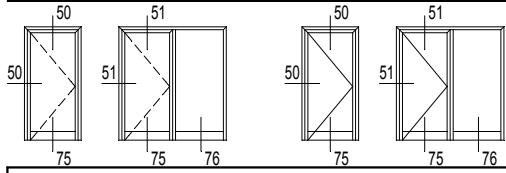

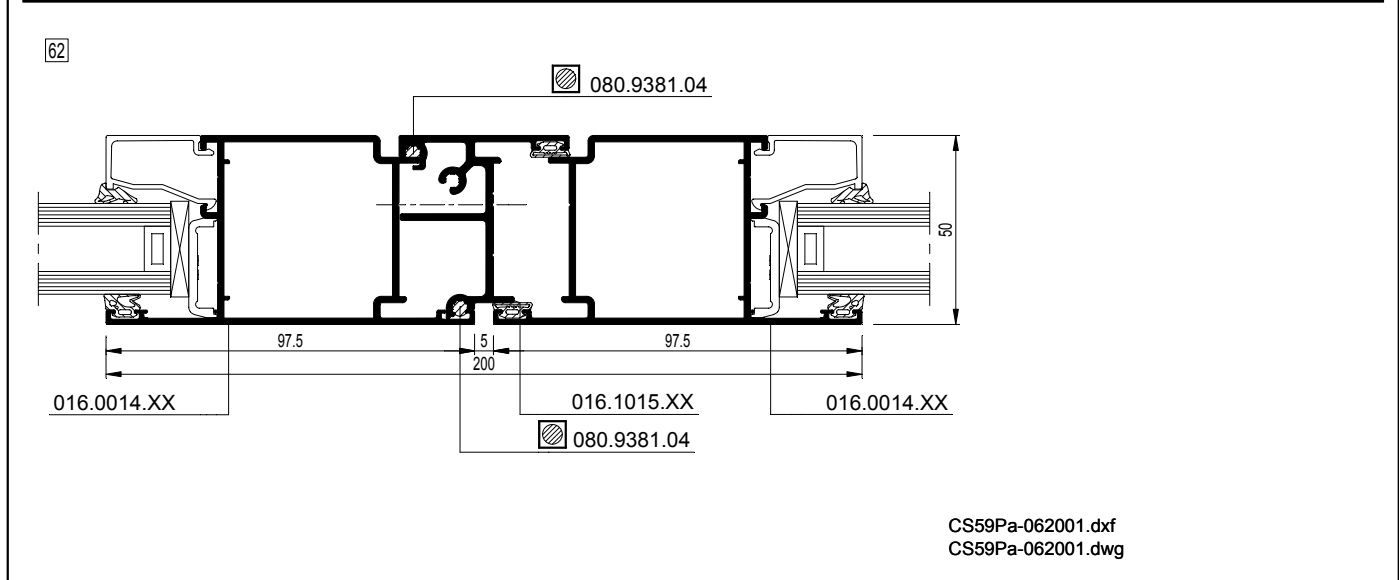
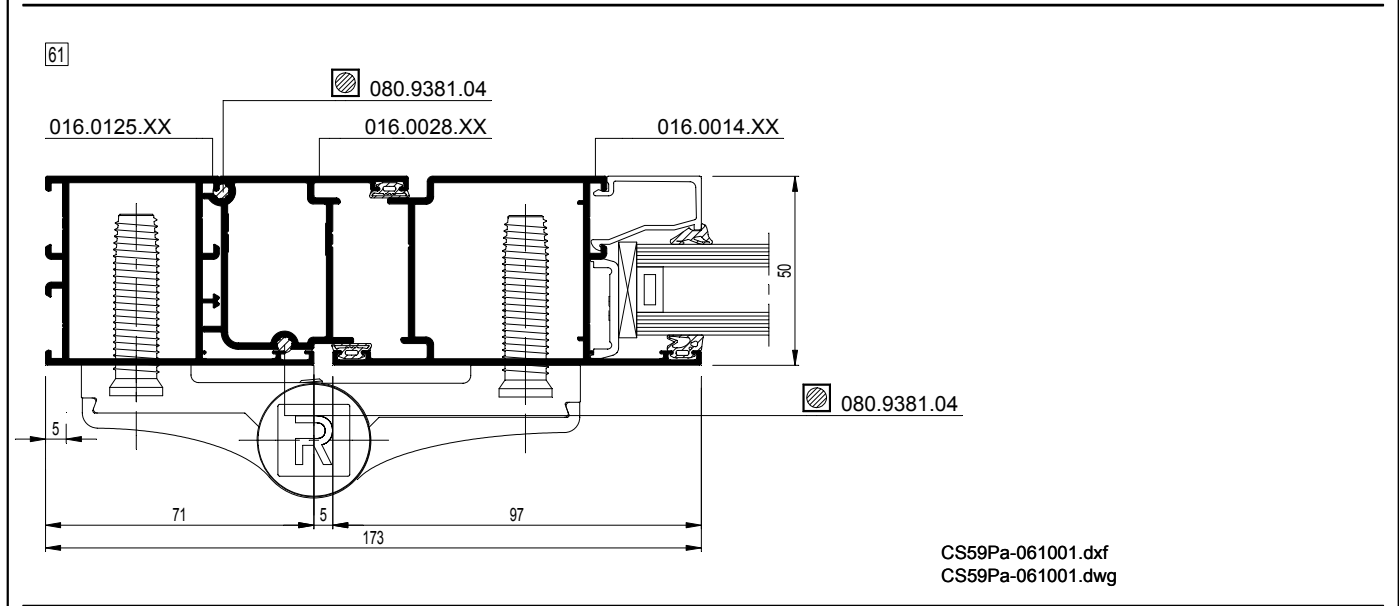
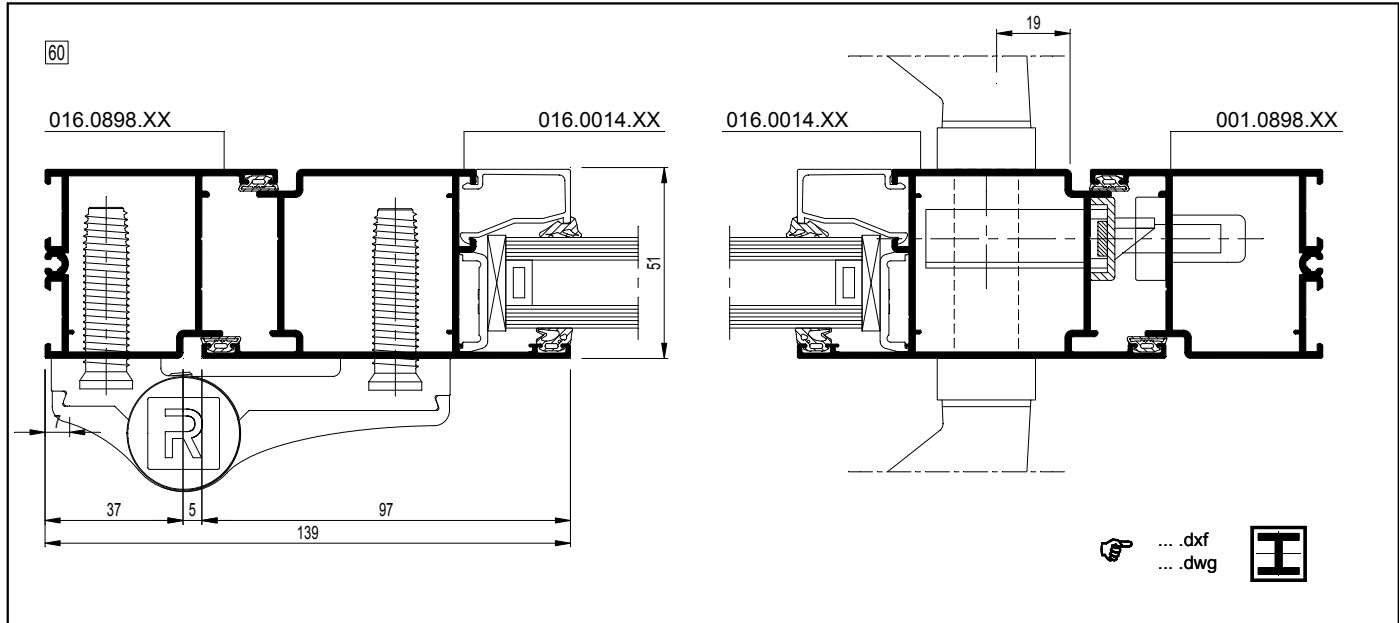
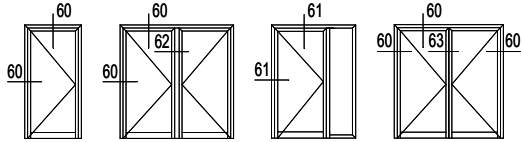

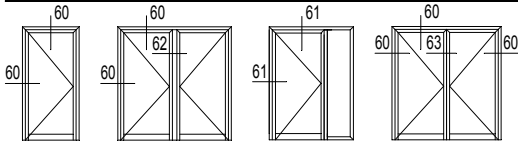

016.0898.XX

$I_x = 13.668 \text{ cm}^4$

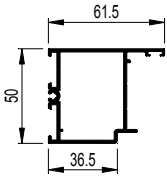

CS-59Pa-060001.dxf  
 CS-59Pa-060001.dwg

016.0026.XX

$I_x = 18.889 \text{ cm}^4$

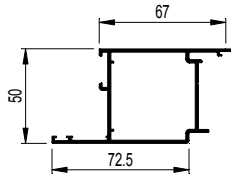

CS-59Pa-060002.dxf  
 CS-59Pa-060002.dwg

ZT

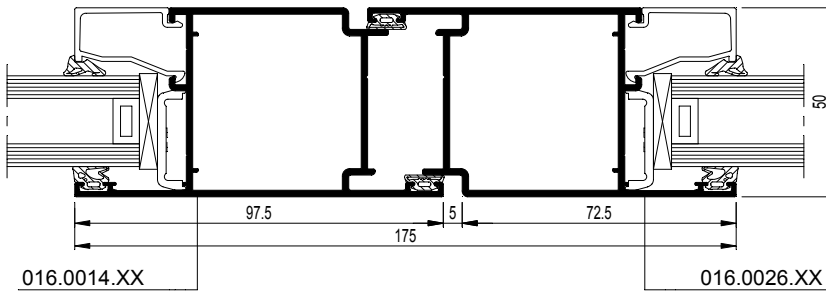

016.0014.XX

016.0026.XX

CS-59Pa-063001.dxf  
 CS-59Pa-063001.dwg

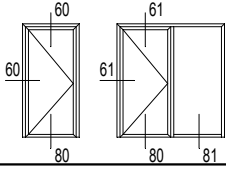

80

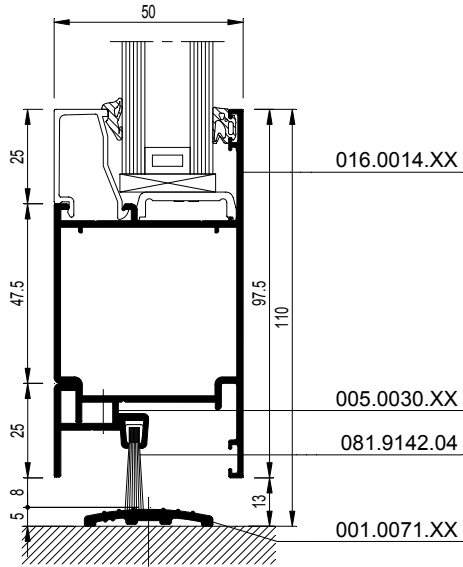

CS59Pa-080001.dxf  
 CS59Pa-080001.dwg

81

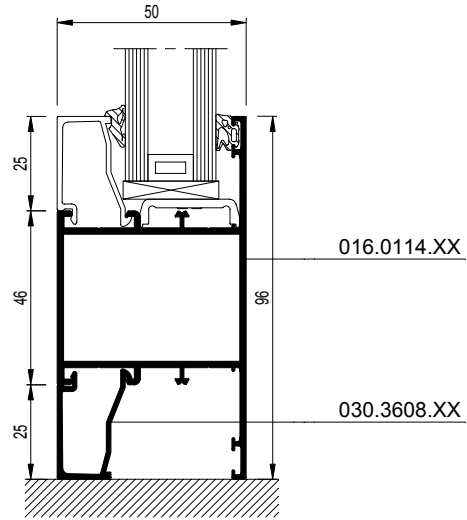

CS59Pa-081001.dxf  
 CS59Pa-081001.dwg

## CS 59Pa



### CS 59Pa Front (CS 59Pa-Fr)

Sliding-tilt door

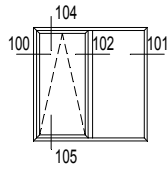

CS 59Pa-Fr - 102

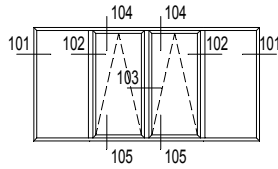

CS 59Pa-Fr - 103

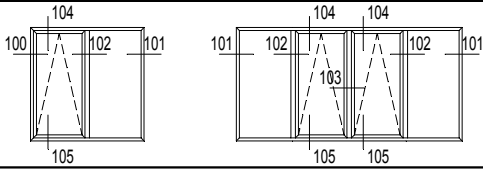

100 11

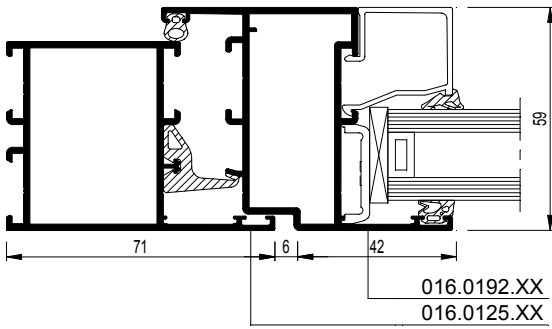

CS59Pa-100001.dxf  
 CS59Pa-100001.dwg

101 1

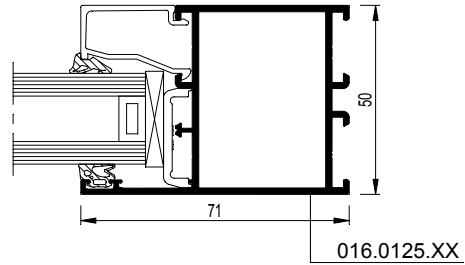

CS59Pa-101001.dxf  
 CS59Pa-101001.dwg

102 21

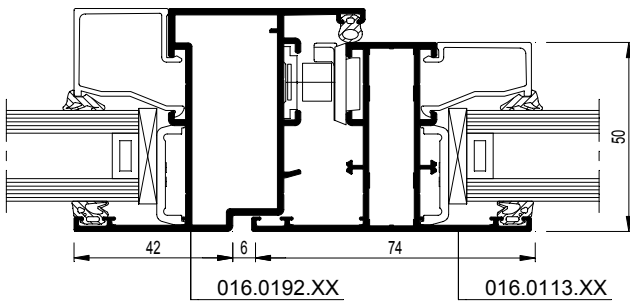

CS59Pa-102001.dxf  
 CS59Pa-102001.dwg

103 12

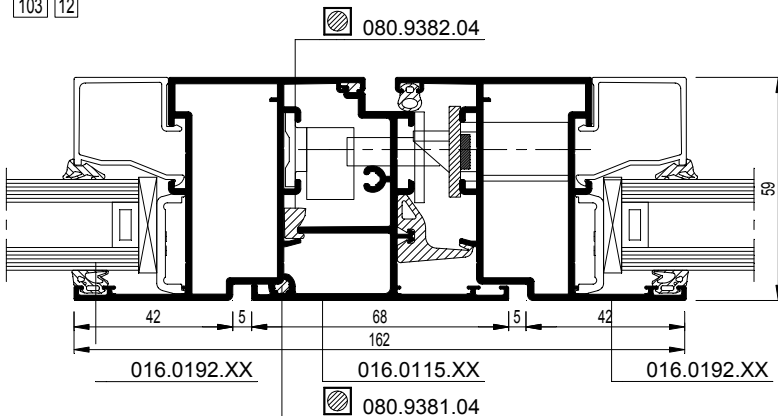

CS59Pa-103001.dxf  
 CS59Pa-103001.dwg

# CS 59Pa-Fr

Schuif-kipdeur  
 Porte coulissante-battante  
 Sliding tilt door  
 Schiebe-kipptür

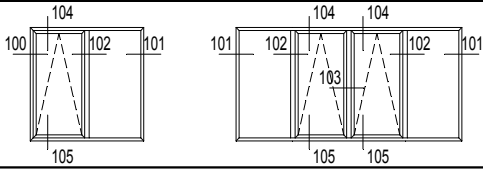

104

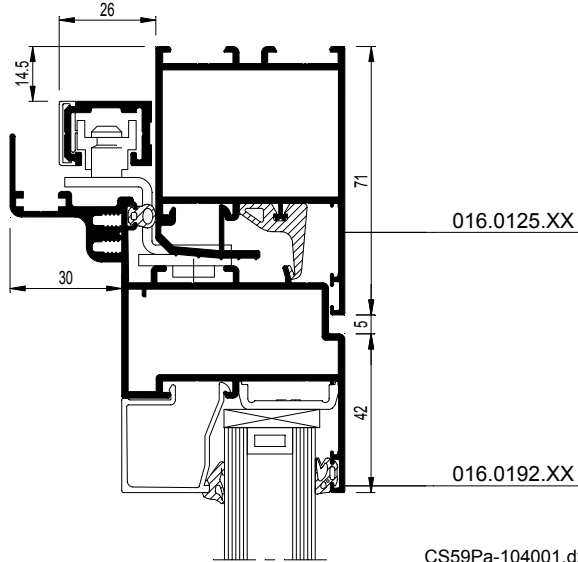

CS59Pa-104001.dxf  
 CS59Pa-104001.dwg

105

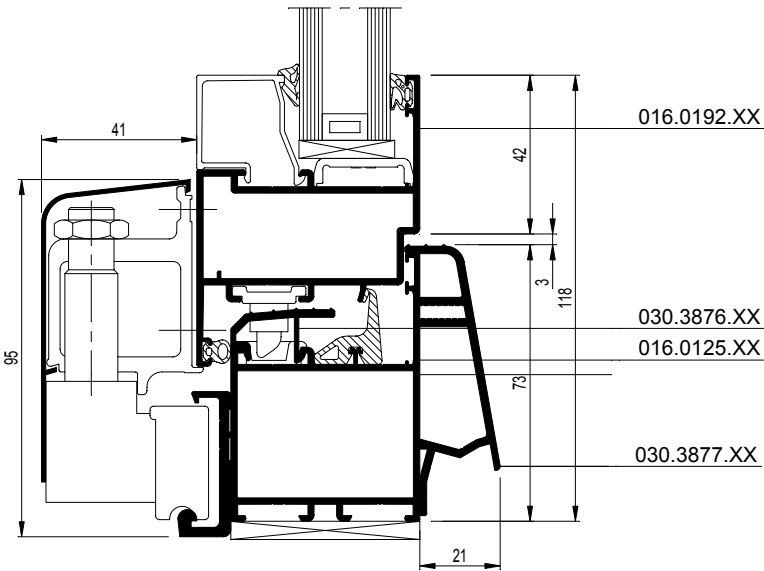

CS59Pa-105001.dxf  
 CS59Pa-105001.dwg

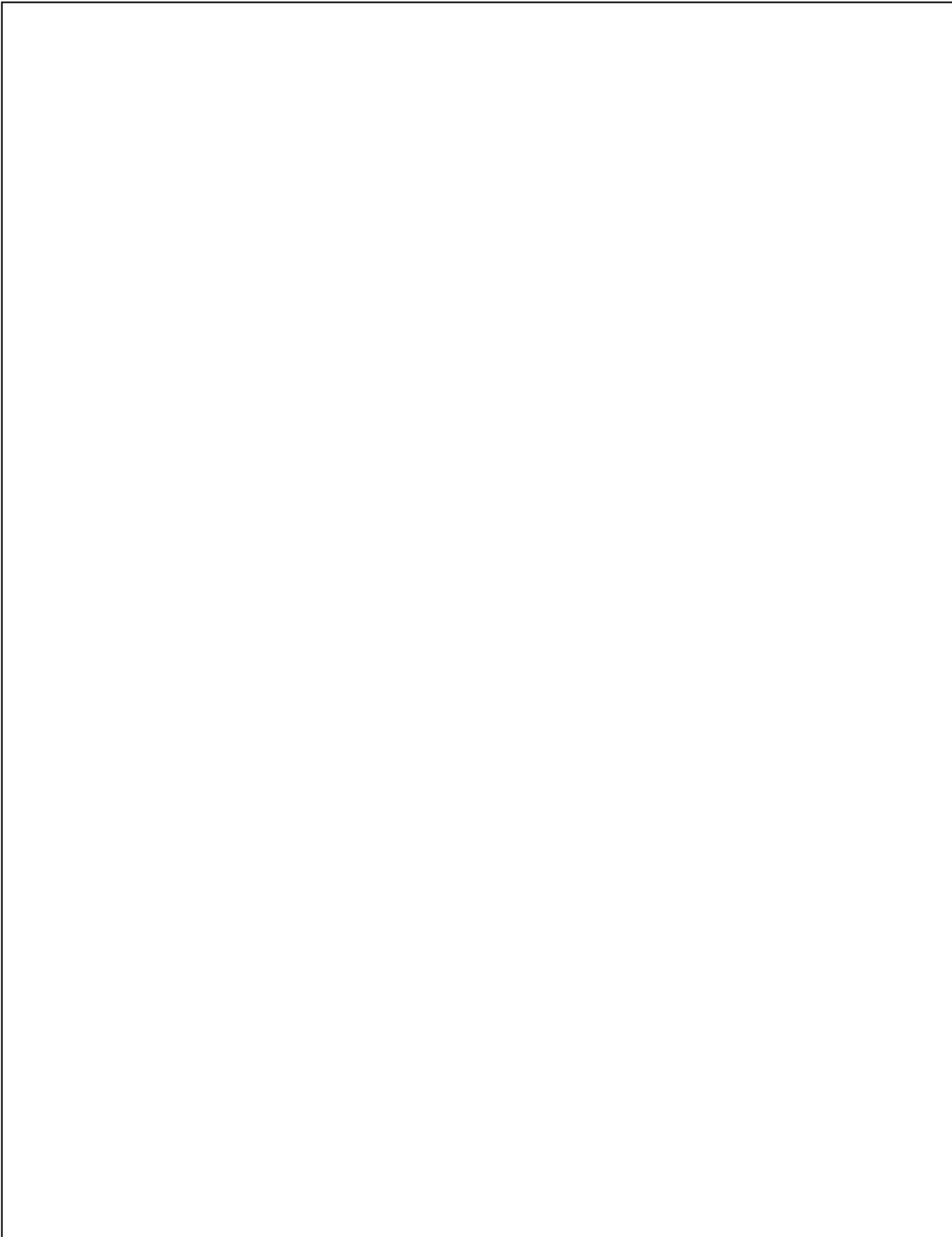





### CS 59Pa Automatic Sliding Door (CS 59Pa-AD)

Sliding doors

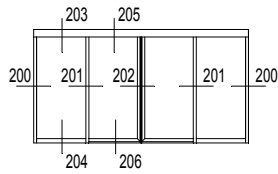

CS 59Pa - 202  
CS 59Pa - 203  
CS 59Pa - 204

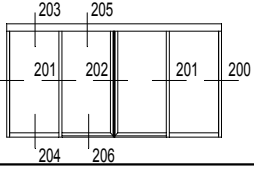

200

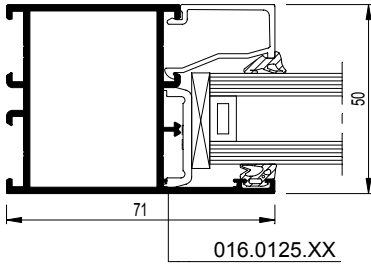

016.0125.XX

CS59Pa-200001.dxf  
CS59Pa-200001.dwg

201

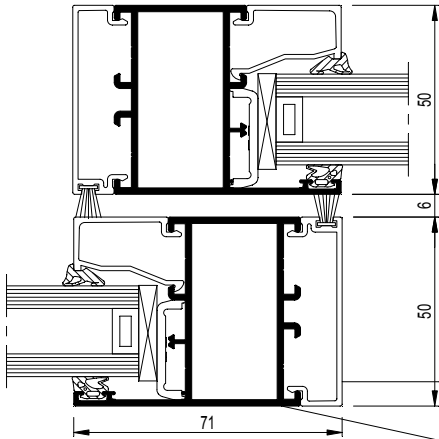

016.0590.XX

016.0183.XX

CS59Pa-201001.dxf  
CS59Pa-201001.dwg

202

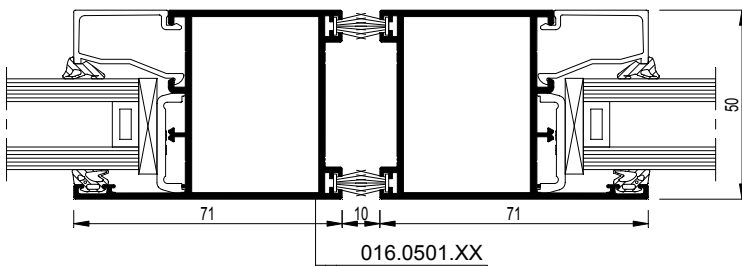

016.0501.XX

CS59Pa-202001.dxf  
CS59Pa-202001.dwg

# CS 59Pa-AD

Automatische schuifdeuren  
Portes coulissantes automatiques  
Automatic sliding door  
Automatische Schiebetüren

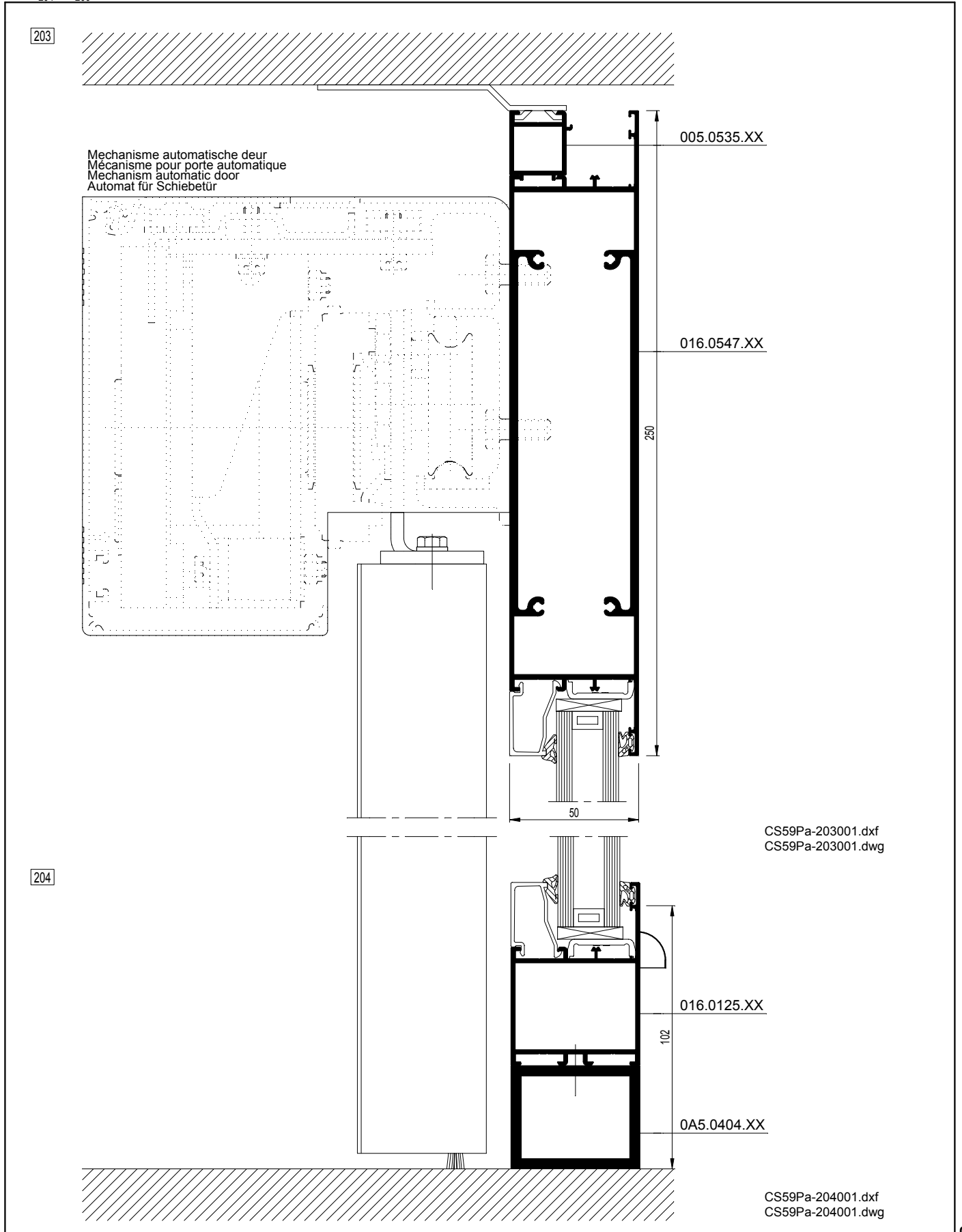
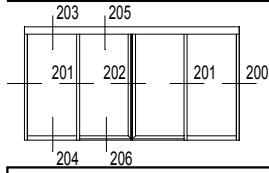

# CS 59Pa-AD

Automatische schuifdeuren  
Portes coulissantes automatiques  
Automatic sliding door  
Automatische Schiebetüren

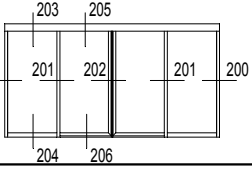

205

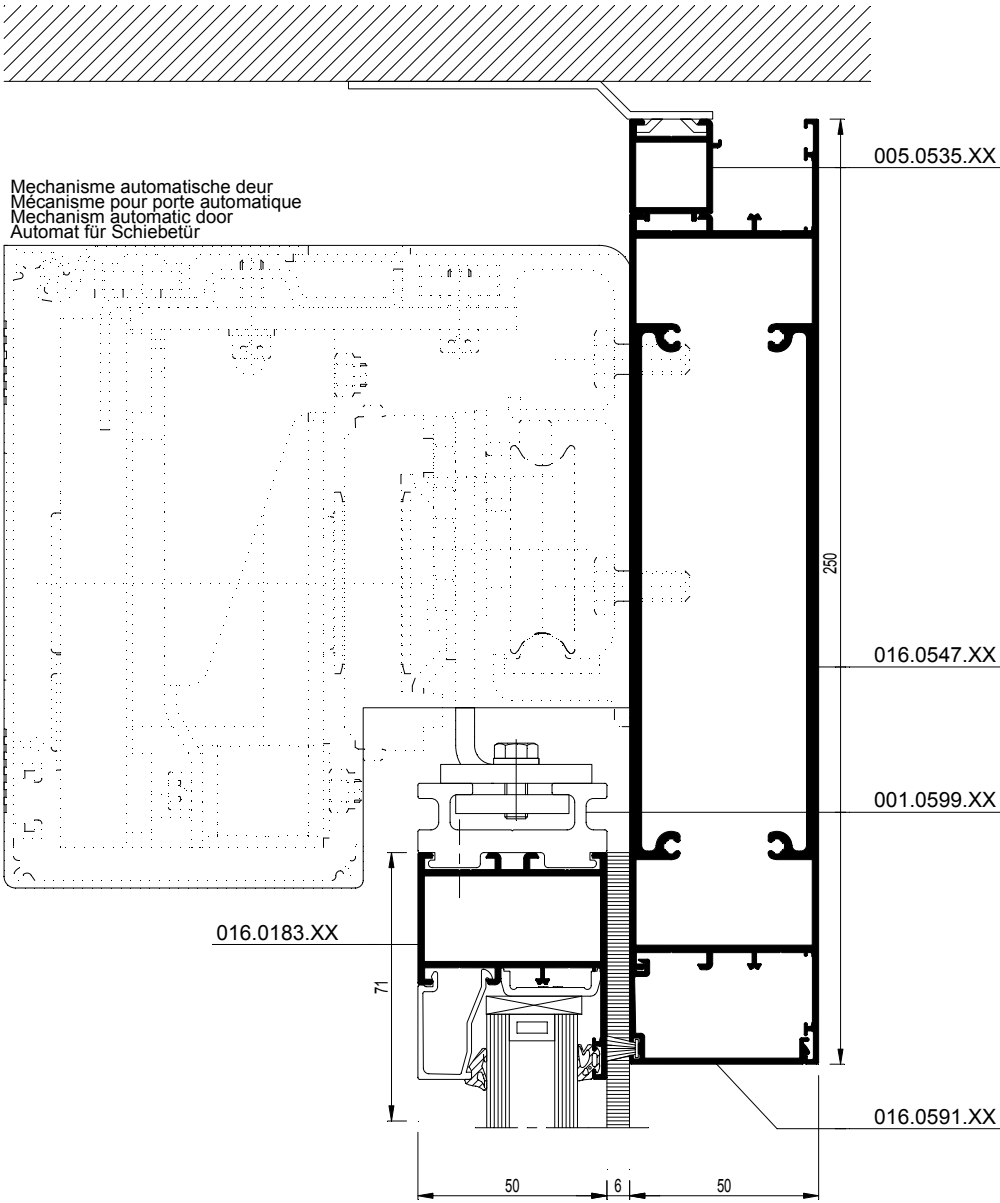

206

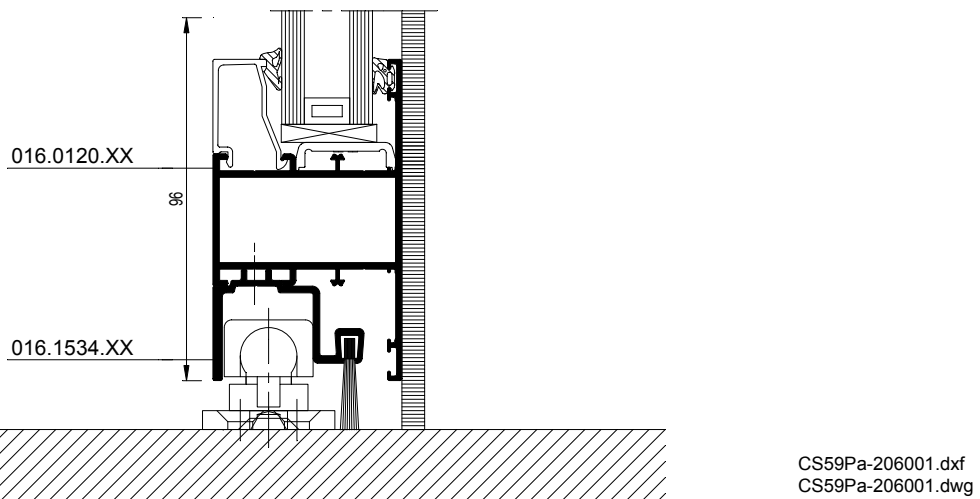



## CS 59Pa Swing Door (CS 59Pa-SD)

### 1 Door with finger protection

Overhead closer door with finger protection

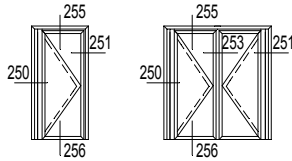

CS 59Pa - 250  
CS 59Pa - 251

Bodentuerschliesser Tür mit Fingerschutz

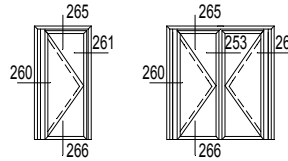

CS 59Pa - 256  
CS 59Pa - 257

### 2 Door without finger protection

Overhead closer door without finger protection

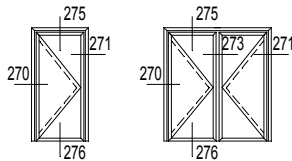

CS 59Pa - 260  
CS 59Pa - 261

Floor closer door without finger protection

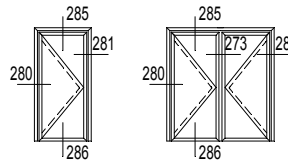

CS 59Pa - 266  
CS 59Pa - 267

# CS 59Pa-SD

Deur met vingerbeveiliging - Kozijndorpelveer deur met vingerbeveiliging  
 Porte avec anti-pince-doigts - Pivot de frein aerien porte avec anti-pince-doigts  
 Door with finger protection - Overhead closer door with finger protection  
 Einzelne Tür mit Fingerschutz - Rohrtuerschliesser Tür mit Fingerschutz

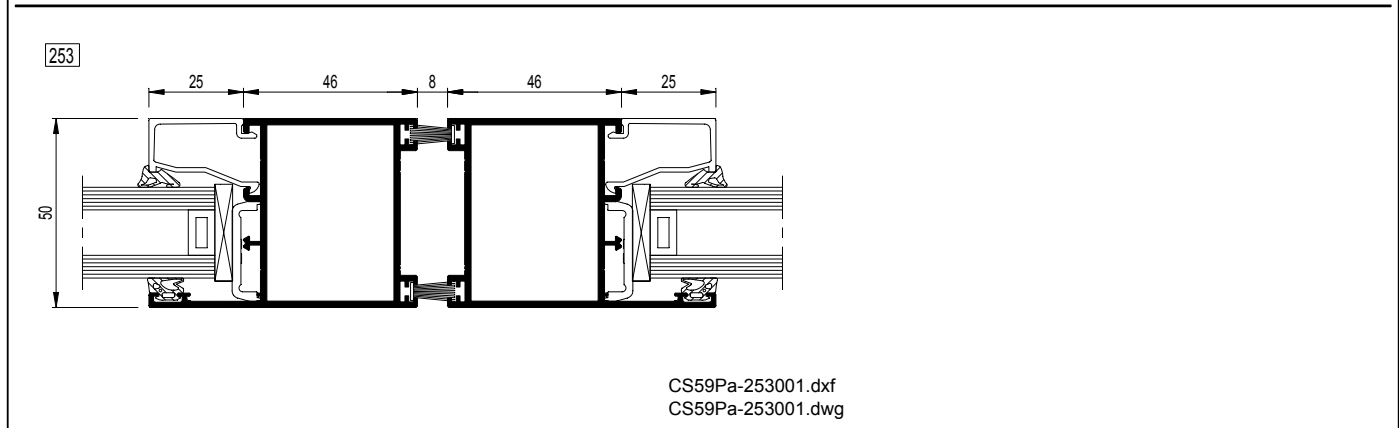
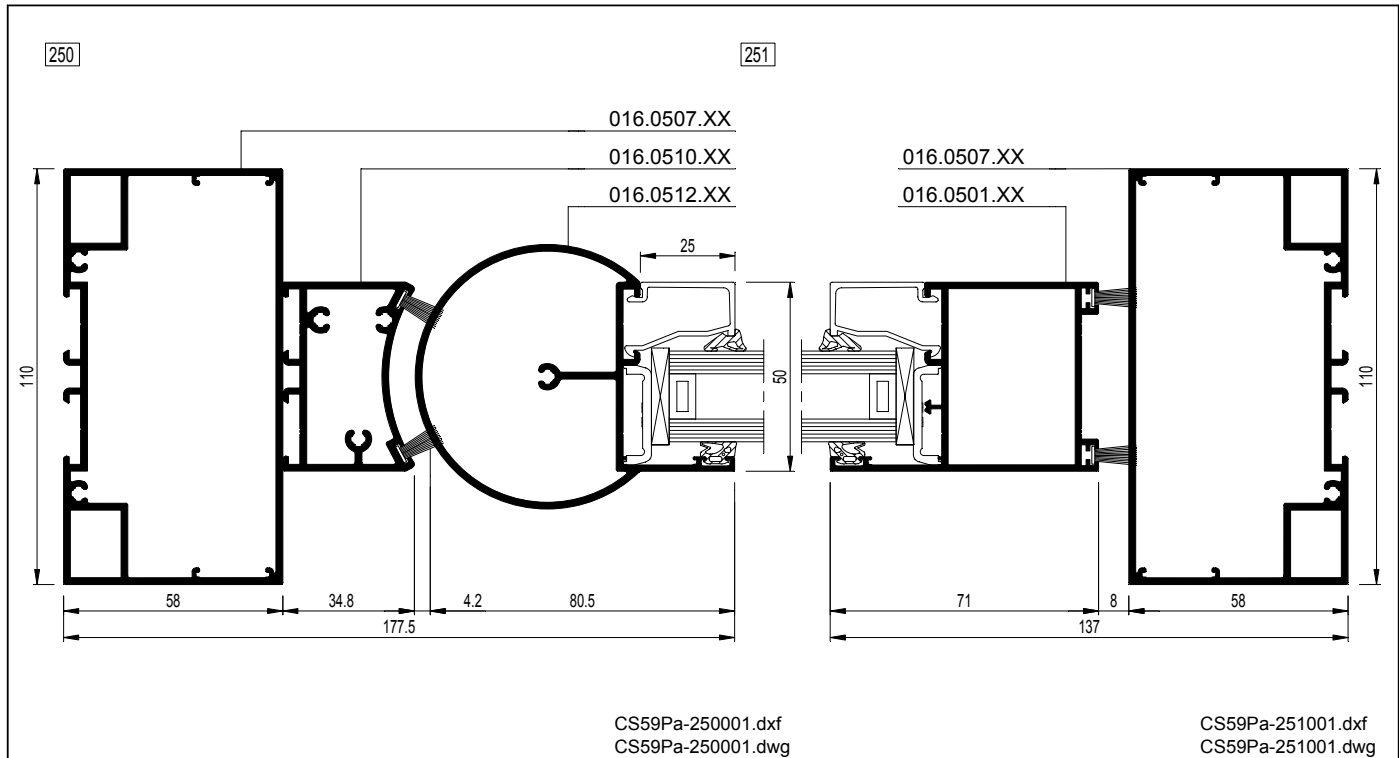
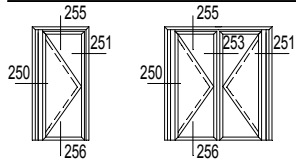

# CS 59Pa-SD

Deur met vingerbeveiliging - Kozijndorpelveer deur met vingerbeveiliging  
Porte avec anti-pince-doigts - Pivot de frein aerien porte avec anti-pince-doigts  
Door with finger protection - Overhead closer door with finger protection  
Einzelne Tür mit Fingerschutz - Rohrtuerschliesser Tür mit Fingerschutz

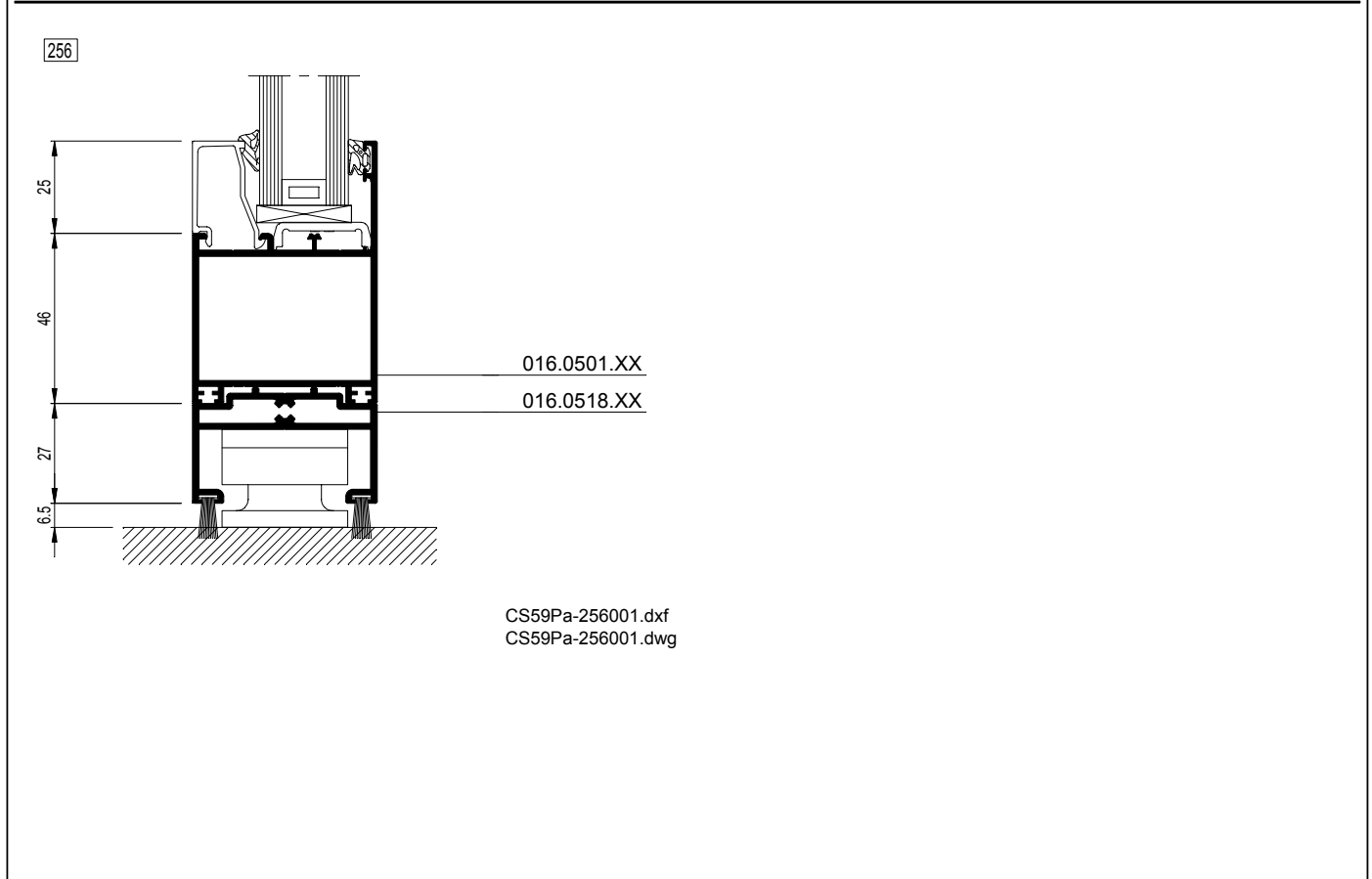
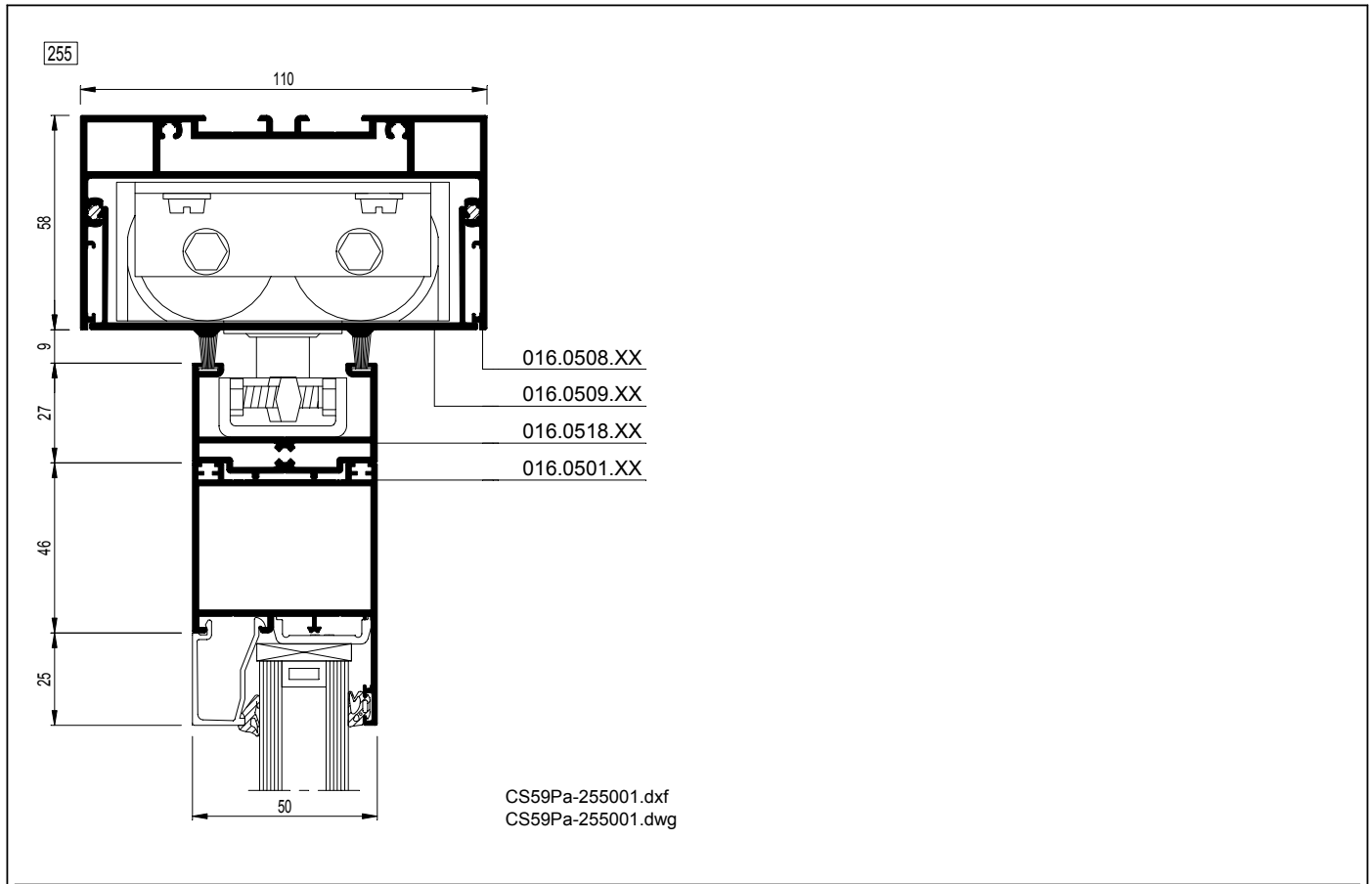
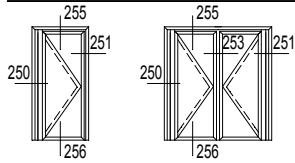

# CS 59Pa-SD

Deur met vingerbeveiliging - Vloerveer deur met vingerbeveiliging  
 Porte avec anti-pince-doigts - Pivot de frein au sol porte avec anti-pince-doigts  
 Door with finger protection - Floor closer door with finger protection  
 Einzelne Tür mit Fingerschutz - Bodentuerschliesser Tür mit Fingerschutz

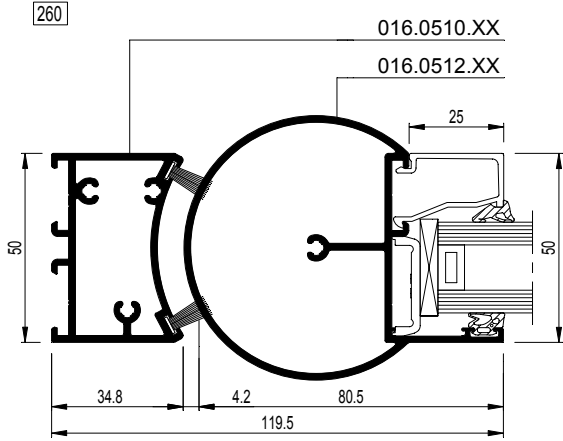
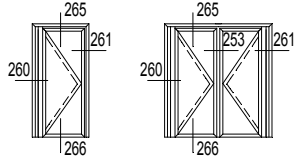

CS59Pa-260001.dxf  
 CS59Pa-260001.dwg

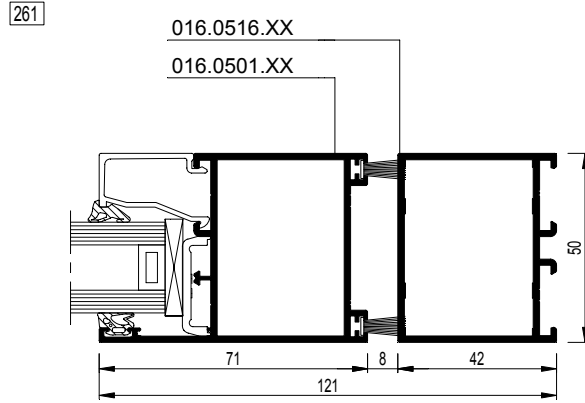

CS59Pa-261001.dxf  
 CS59Pa-261001.dwg

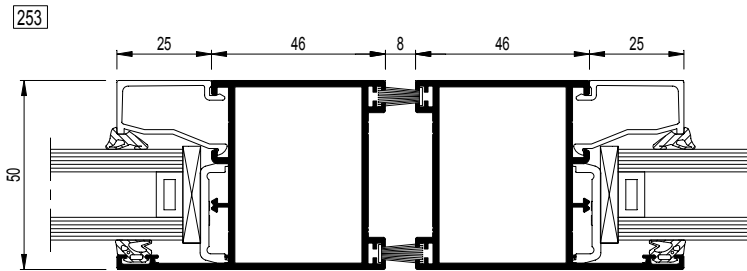

CS59Pa-253001.dxf  
 CS59Pa-253001.dwg



# CS 59Pa-SD

Deur met vingerbeveiliging - Kozjindorpelveer deur met vingerbeveiliging  
Porte avec anti-pince-doigts - Pivots de frein aerien porte avec anti-pince-doigts  
Door with finger protection - Overhead closer door with finger protection  
Einzelne Tür mit Fingerschutz - Rohrtuerschliesser Tür mit Fingerschutz

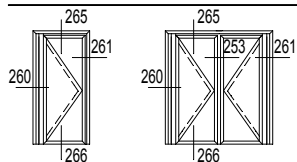

265

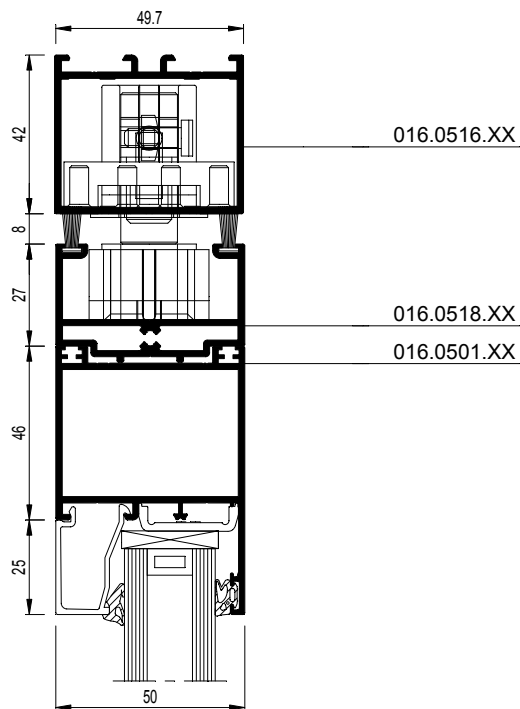

CS59Pa-265001.dxf  
CS59Pa-265001.dwg

266

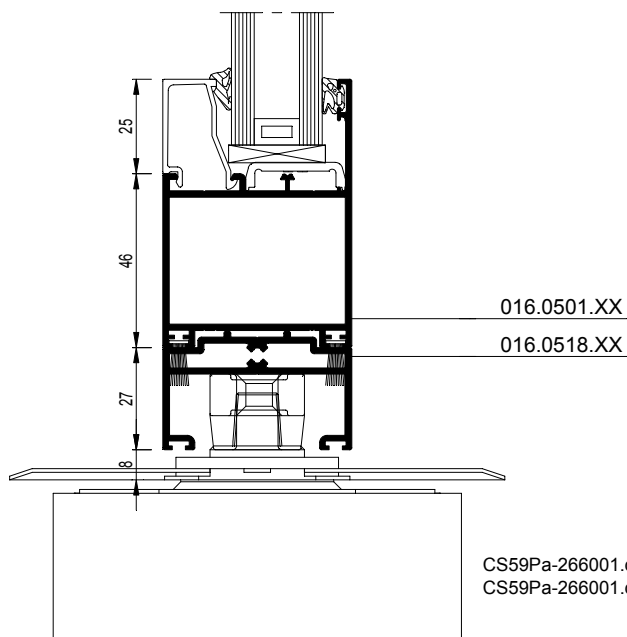

CS59Pa-266001.dxf  
CS59Pa-266001.dwg

# CS 59Pa-SD

Deur zonder vingerbeveiliging - Kozijndorpelveer deur zonder vingerbeveiliging  
 Porte sans anti-pince-doigts - Pivot de frein aerien porte sans anti-pince-doigts  
 Door without finger protection - Overhead closer door without finger protection  
 Einzelne Tür ohne Fingerschutz - Rohrtuerschliesser Tür ohne Fingerschutz

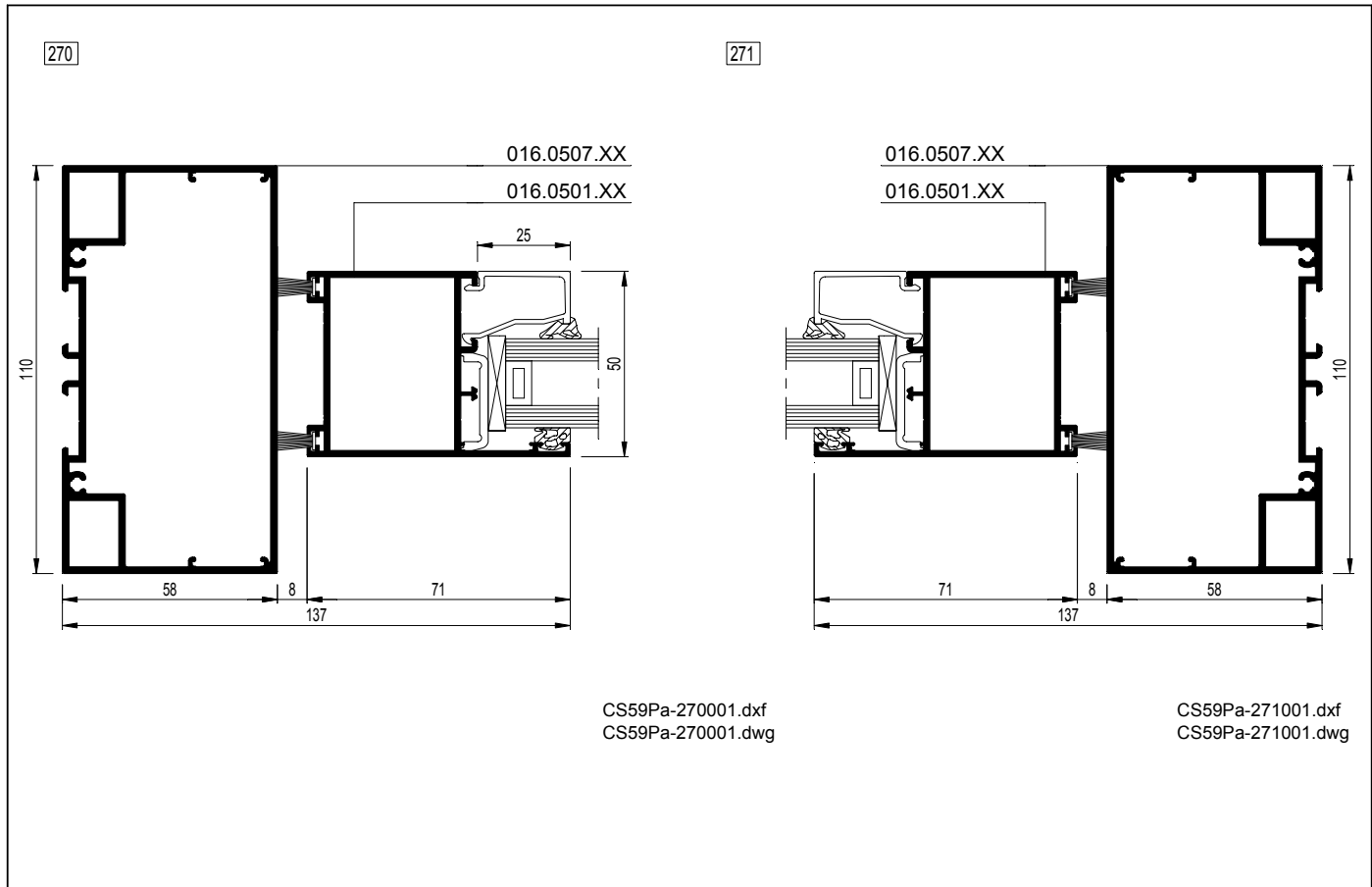
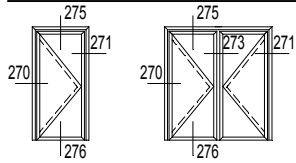

CS59Pa-270001.dxf  
 CS59Pa-270001.dwg

CS59Pa-271001.dxf  
 CS59Pa-271001.dwg

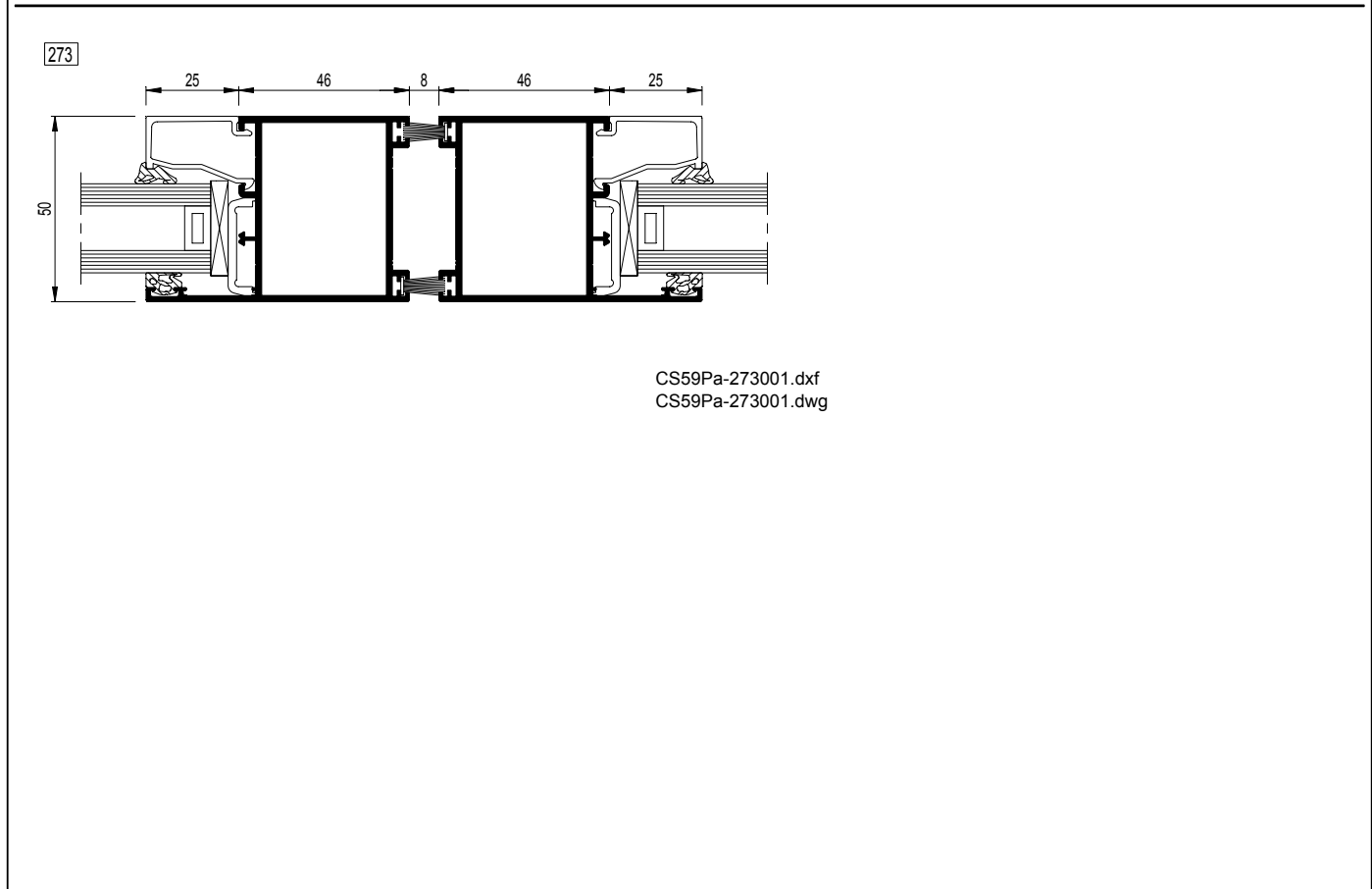

CS59Pa-273001.dxf  
 CS59Pa-273001.dwg

# CS 59Pa-SD

Deur zonder vingerbeveiliging - Kozijndorpelveer deur zonder vingerbeveiliging  
 Porte sans anti-pince-doigts - Pivote de frein aerien porte sans anti-pince-doigts  
 Door without finger protection - Overhead closer door without finger protection  
 Einzelne Tür ohne Fingerschutz - Rohrtuerschliesser Tür ohne Fingerschutz

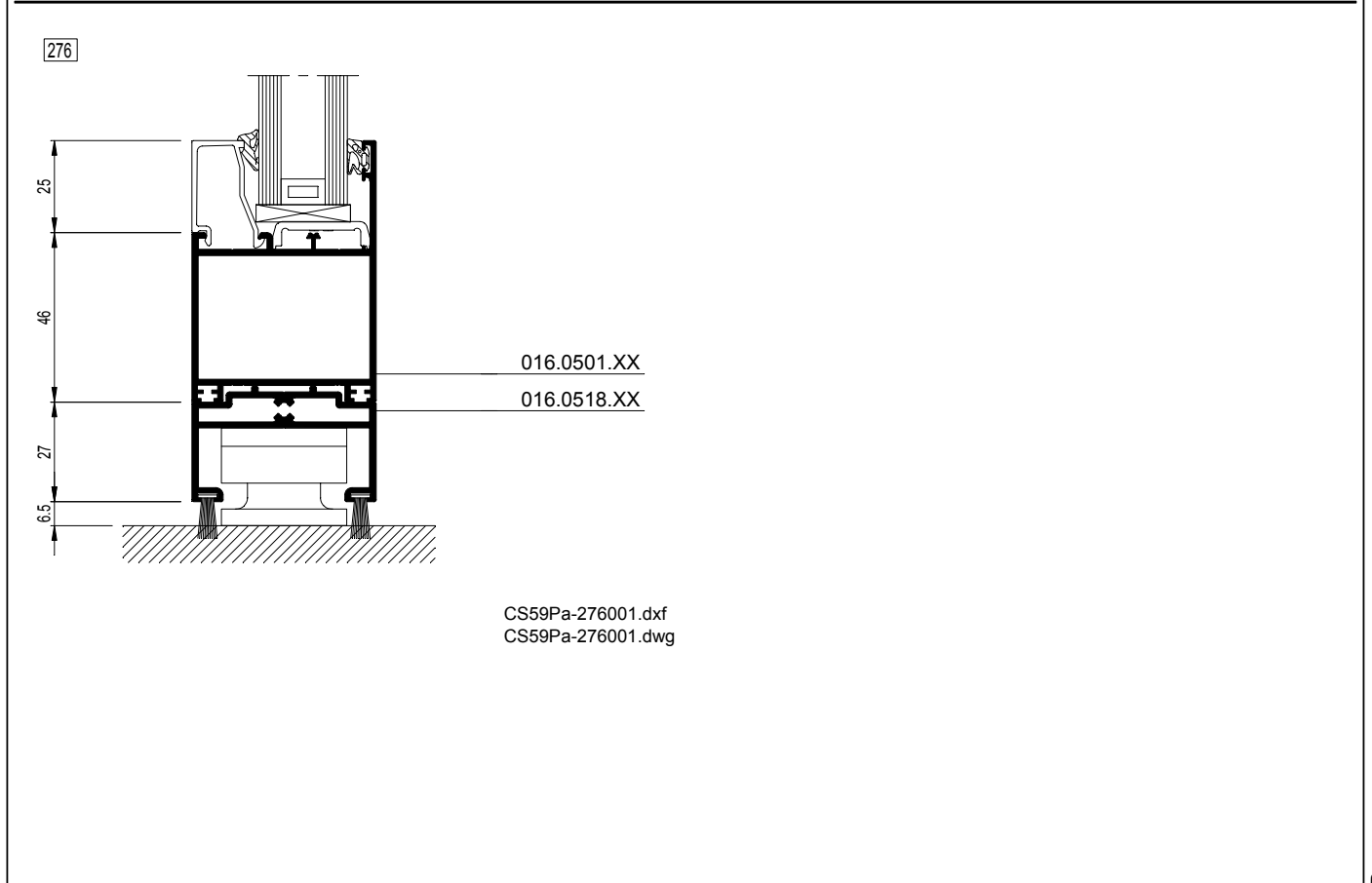
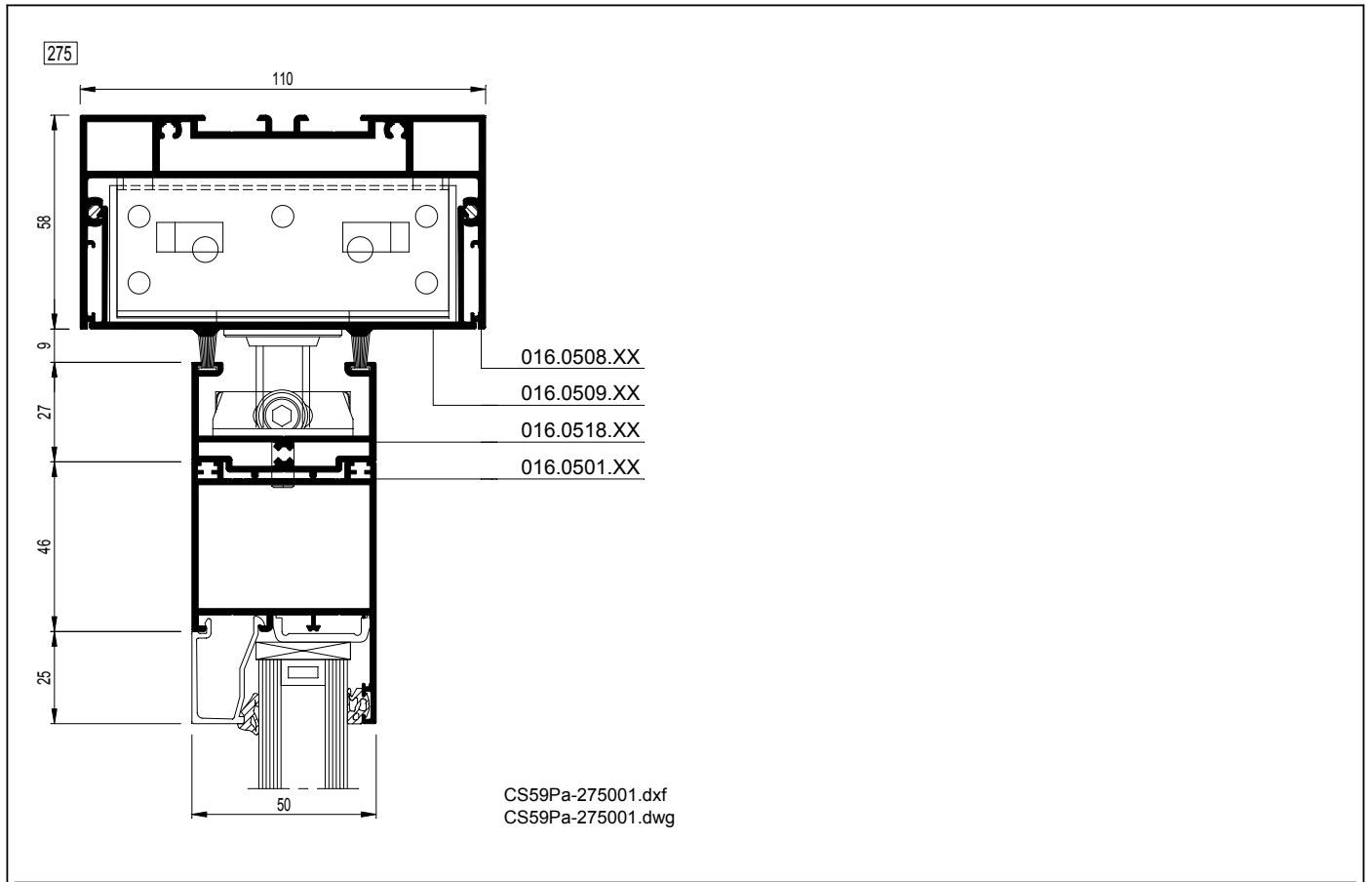
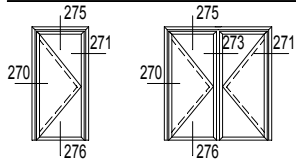

# CS 59Pa-SD

Deur zonder vingerbeveiliging - Vloerveer deur zonder vingerbeveiliging  
 Porte sans anti-pince-doigts - Pivot de frein au sol porte sans anti-pince-doigts  
 Door without finger protection - Floor closer door without finger protection  
 Einzelne Tür ohne Fingerschutz - Bodentuerschliesser Tür ohne Fingerschutz

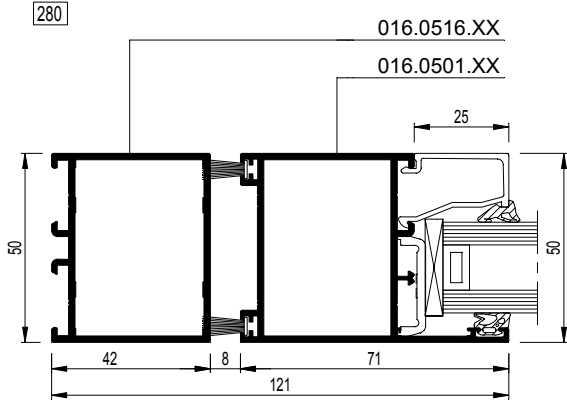
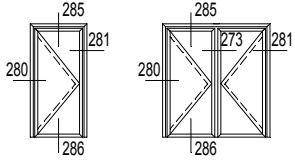

CS59Pa-280001.dxf  
 CS59Pa-280001.dwg

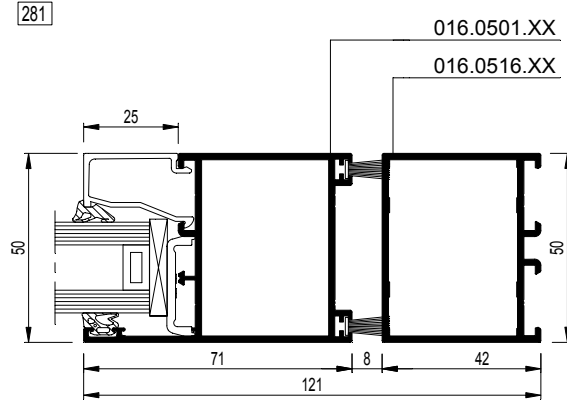

CS59Pa-281001.dxf  
 CS59Pa-281001.dwg

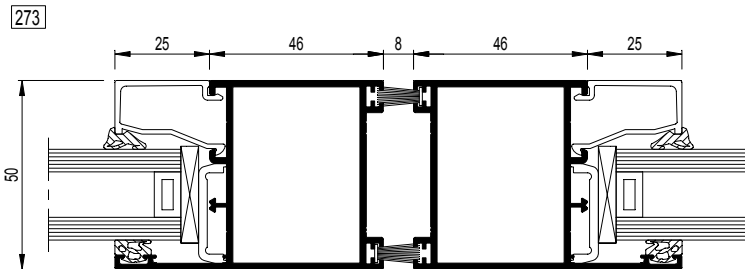

CS59Pa-273001.dxf  
 CS59Pa-273001.dwg

# CS 59Pa-SD

Deur zonder vingerbeveiliging - Vloerveer deur zonder vingerbeveiliging  
 Porte sans anti-pince-doigts - Pivots de frein au sol porte sans anti-pince-doigts  
 Door without finger protection - Floor closer door without finger protection  
 Einzelne Tür ohne Fingerschutz - Bodentuerschliesser Tür ohne Fingerschutz

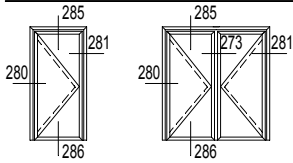

285

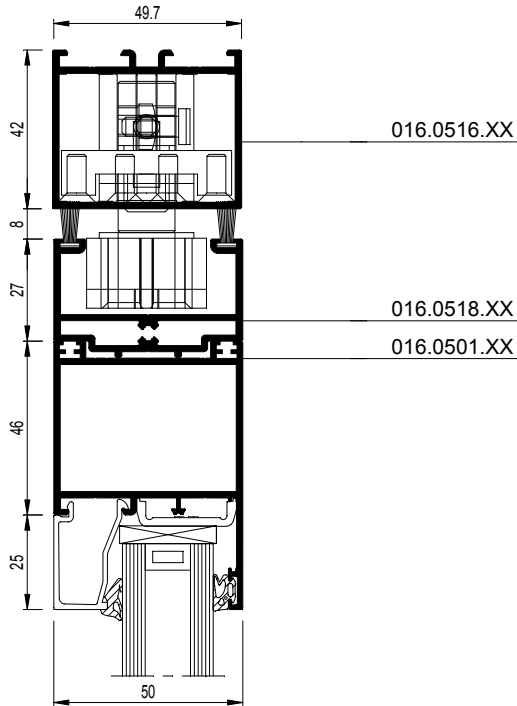

CS59Pa-285001.dxf  
 CS59Pa-285001.dwg

286

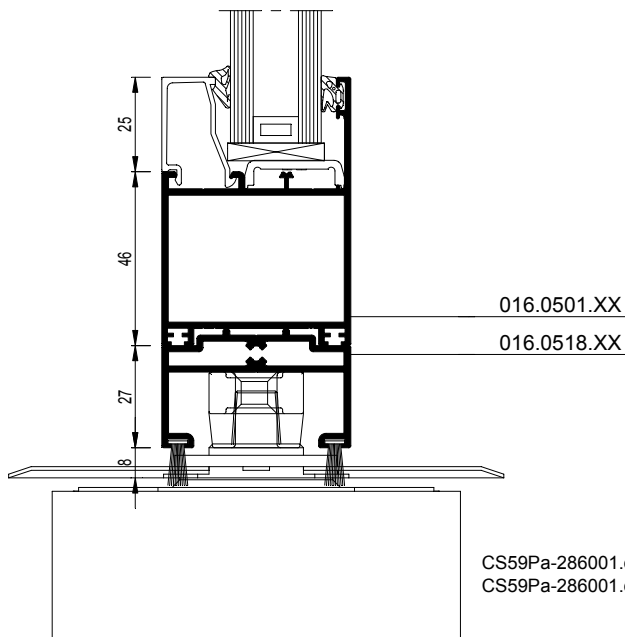

CS59Pa-286001.dxf  
 CS59Pa-286001.dwg

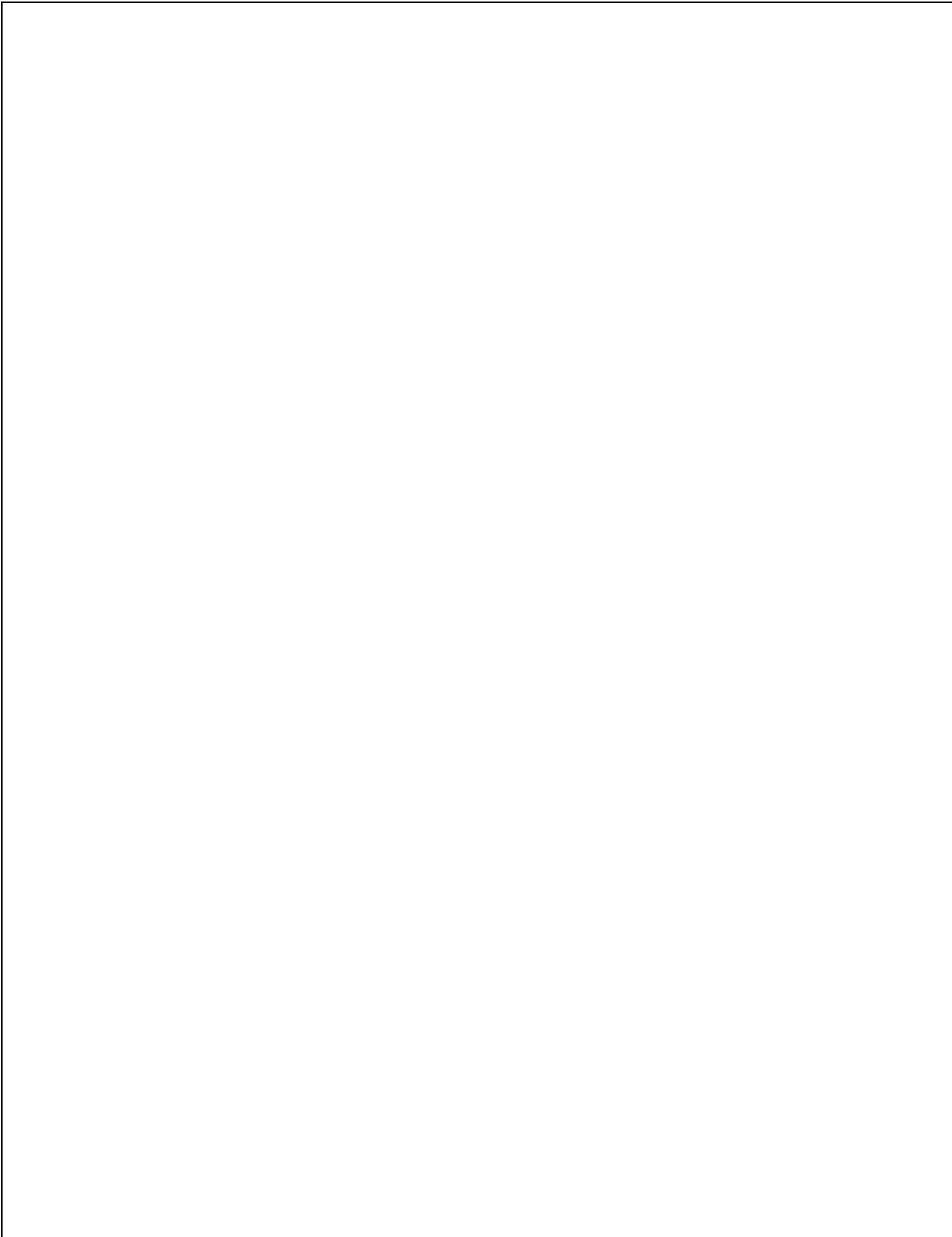

## CS 59Pa



### CS 59Pa Clampable Door (CS 59Pa-CD)

#### 1 Doors inward opening

##### Inward opening doors

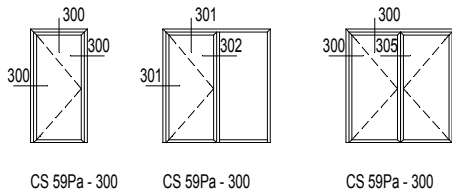

##### Inward opening doors with vent crimped all round

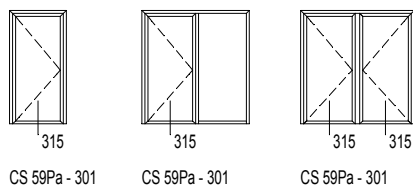

##### Doors with transom-mullion

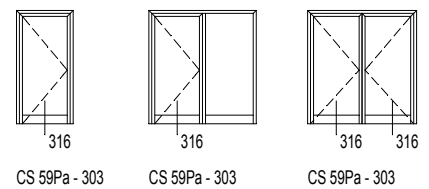

#### 2 Doors outward opening

##### Outward opening doors

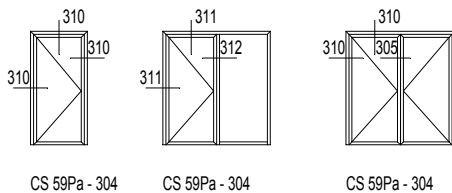

##### Outward opening doors with vent crimped all round

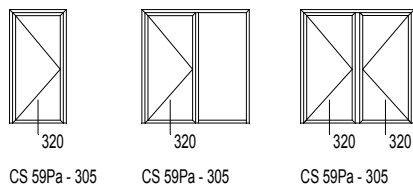

##### Doors with transom-mullion

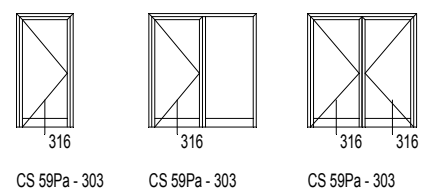

# CS 59Pa-CD

Deuren naar binnen draaiend - Naar binnen opengaande deuren  
 Portes ouvrant vers l'intérieur - Portes ouvrant vers l'intérieur  
 Doors inward opening - Inward opening doors  
 Türen nach innen öffnend - Nach innen öffnende Türen

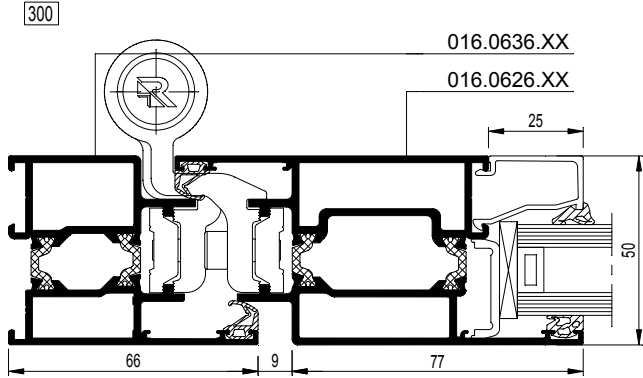
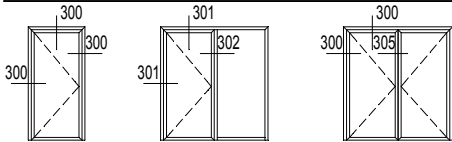

CS59-300001.dxf  
 CS59-300001.dwg

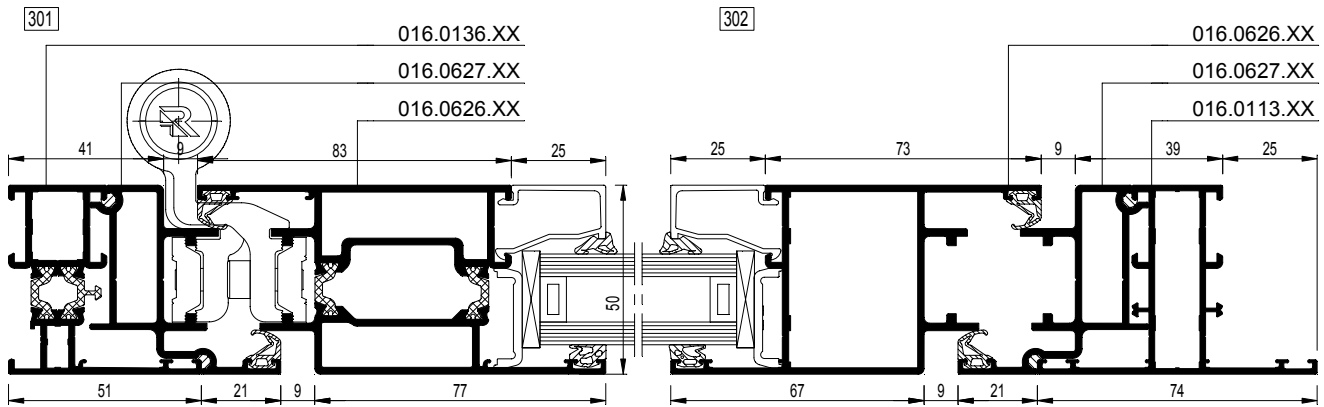

CS59-301001.dxf  
 CS59-301001.dwg

CS59-302001.dxf  
 CS59-302001.dwg

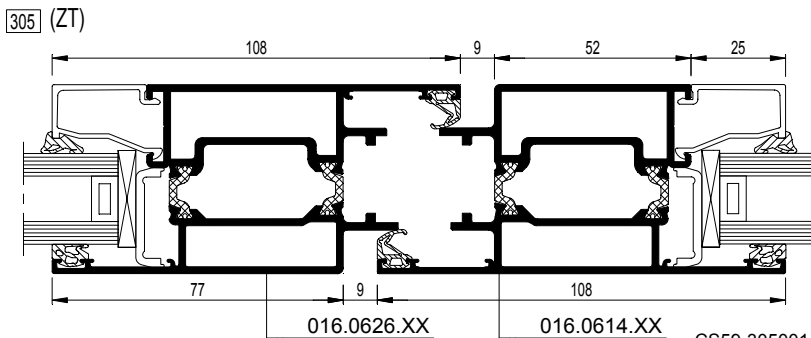

CS59-305001.dxf  
 CS59-305001.dwg



# CS 59Pa-CD

Deuren naar binnen draaiend - Vleugel rondom geperst  
Portes ouvrant vers l'intérieur - Ouvrant serti tout autour  
Doors inward opening - Vent crimped all round  
Türen nach innen öffnend - Rundherum gepresstem Türflügel

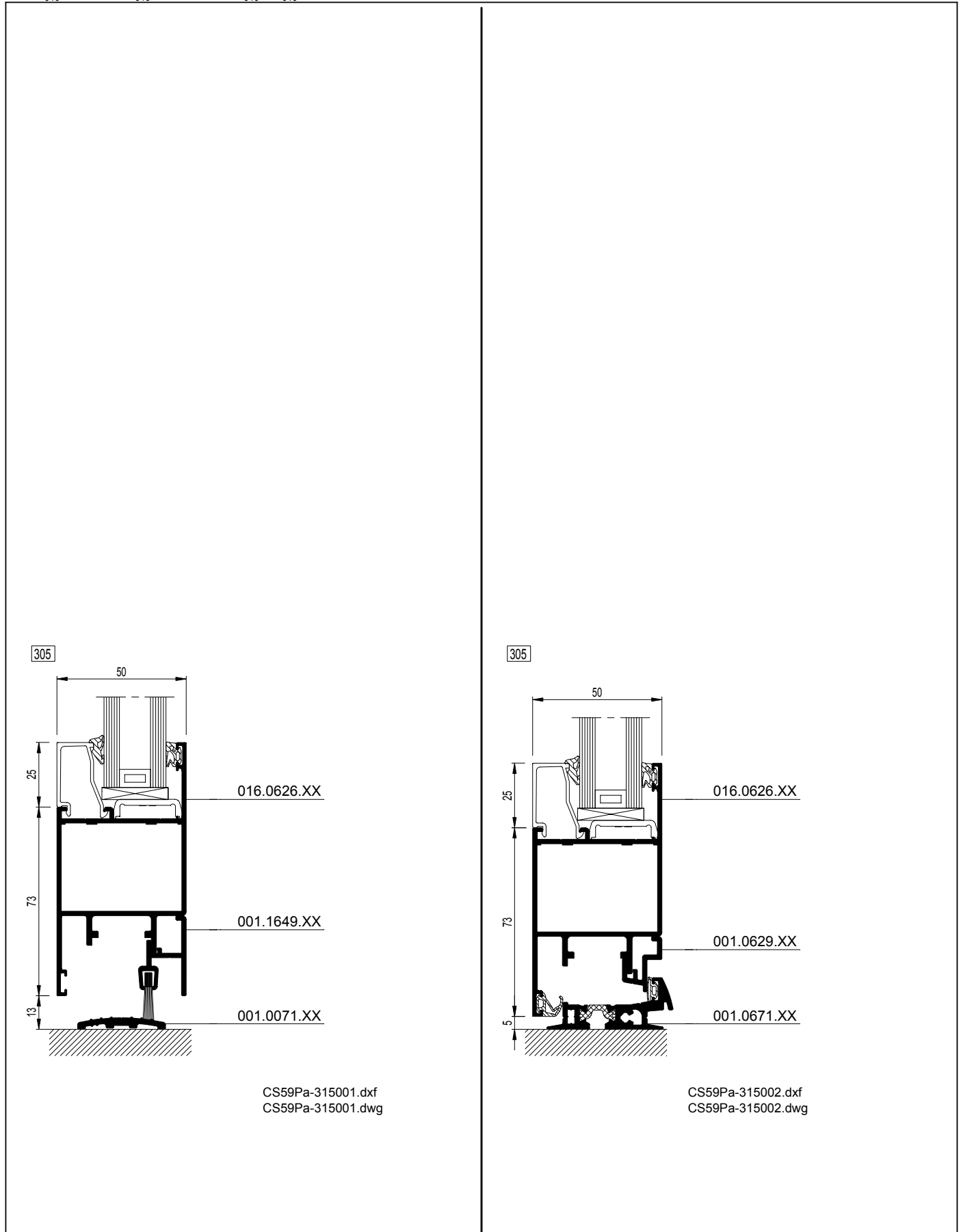
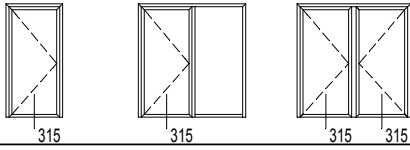

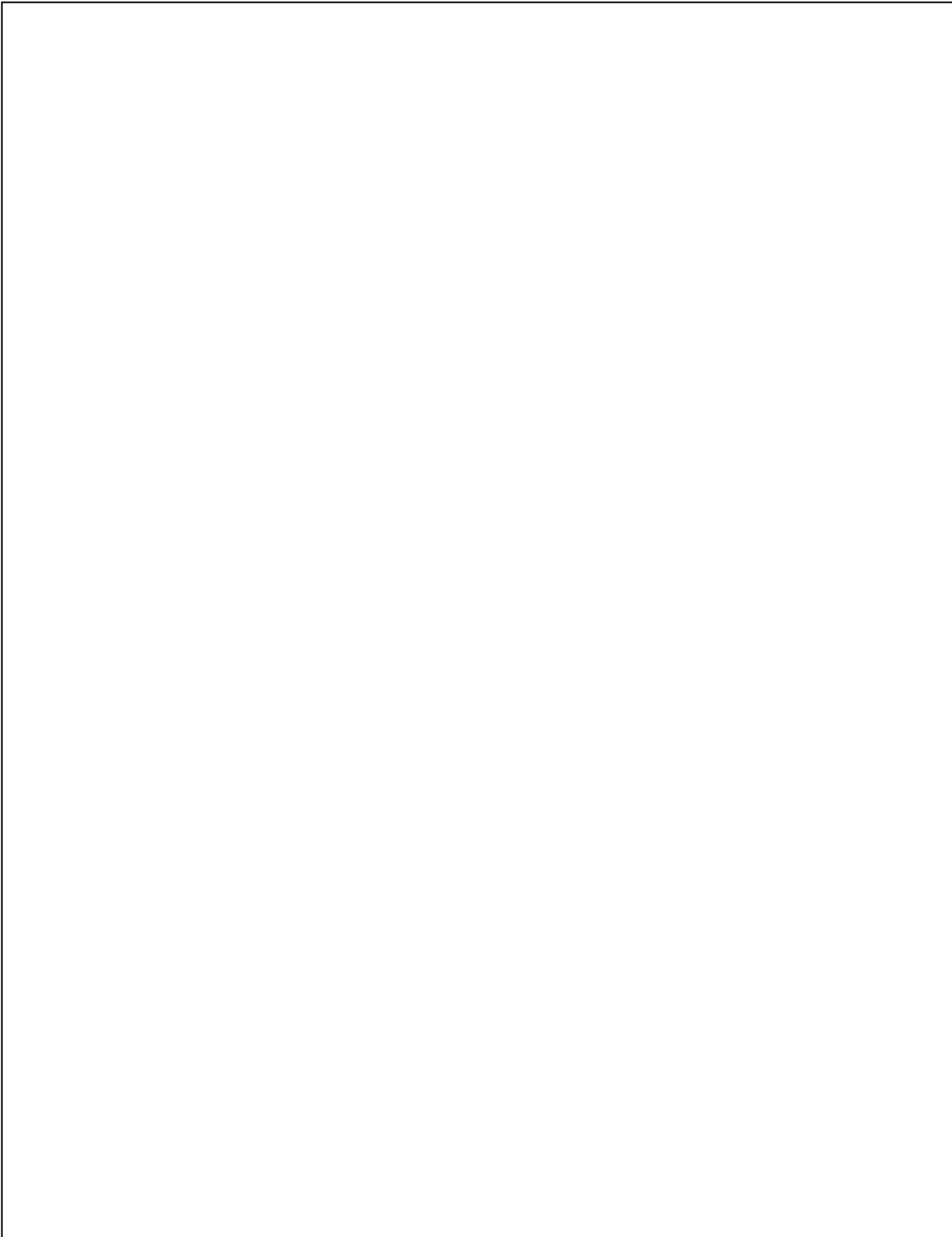

# CS 59Pa-CD

Deuren - Deuren met T-profiel  
Portes - Portes avec traverse  
Doors - Doors with transom-mullion  
Türen - Türen mit T-profilsockel

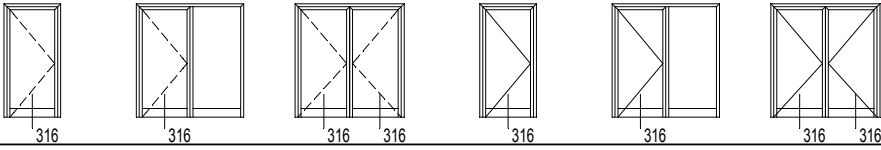

305

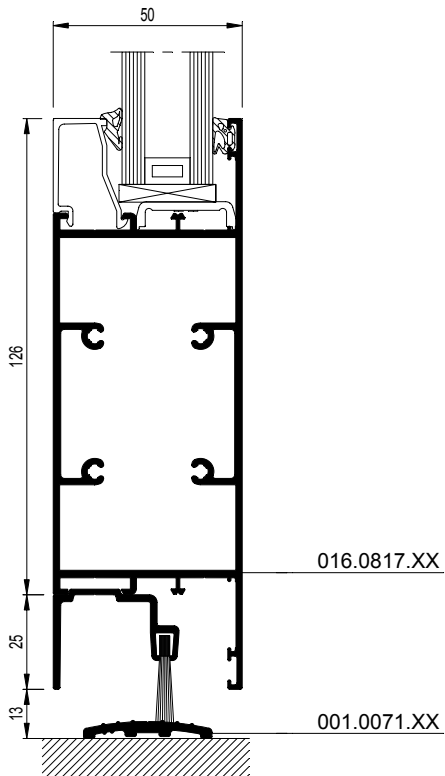

CS59Pa-316001.dxf  
CS59Pa-316001.dwg

# CS 59Pa-CD

Deuren naar buiten draaiend - Naar buiten opengaande deuren  
 Portes ouvrant vers l'extérieur - Portes ouvrant vers l'extérieur  
 Doors outward opening - Outward opening doors  
 Türen nach außen öffnend - Nach außen öffnende Türen

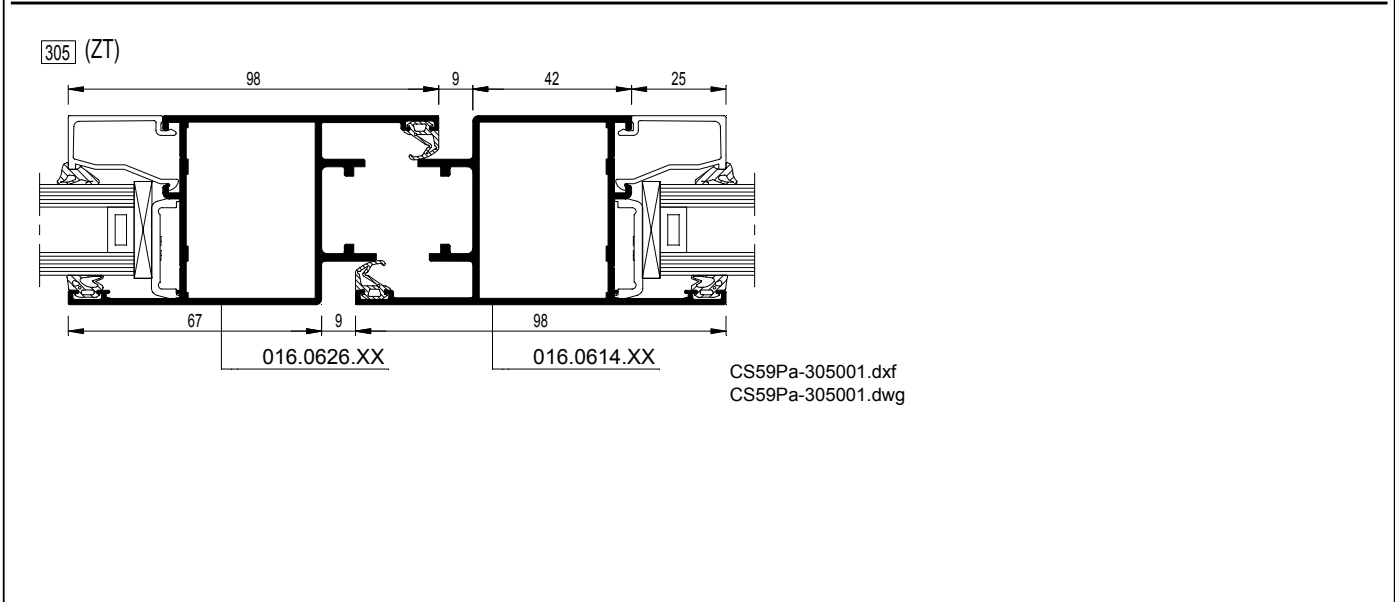
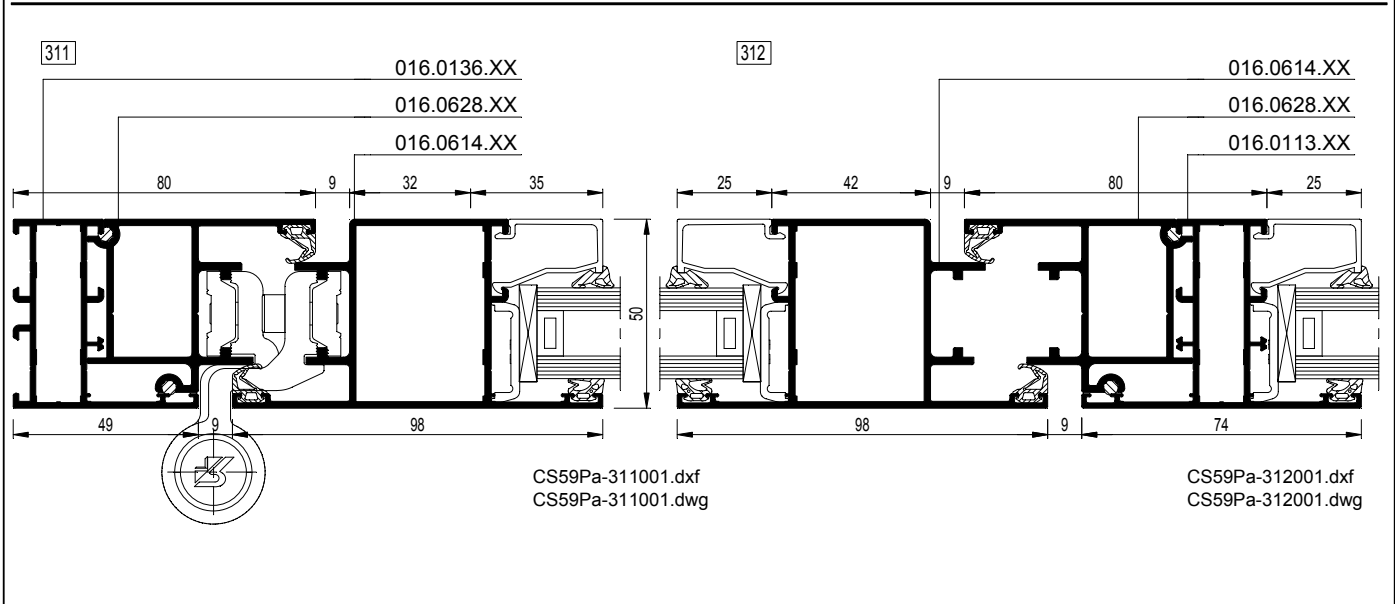
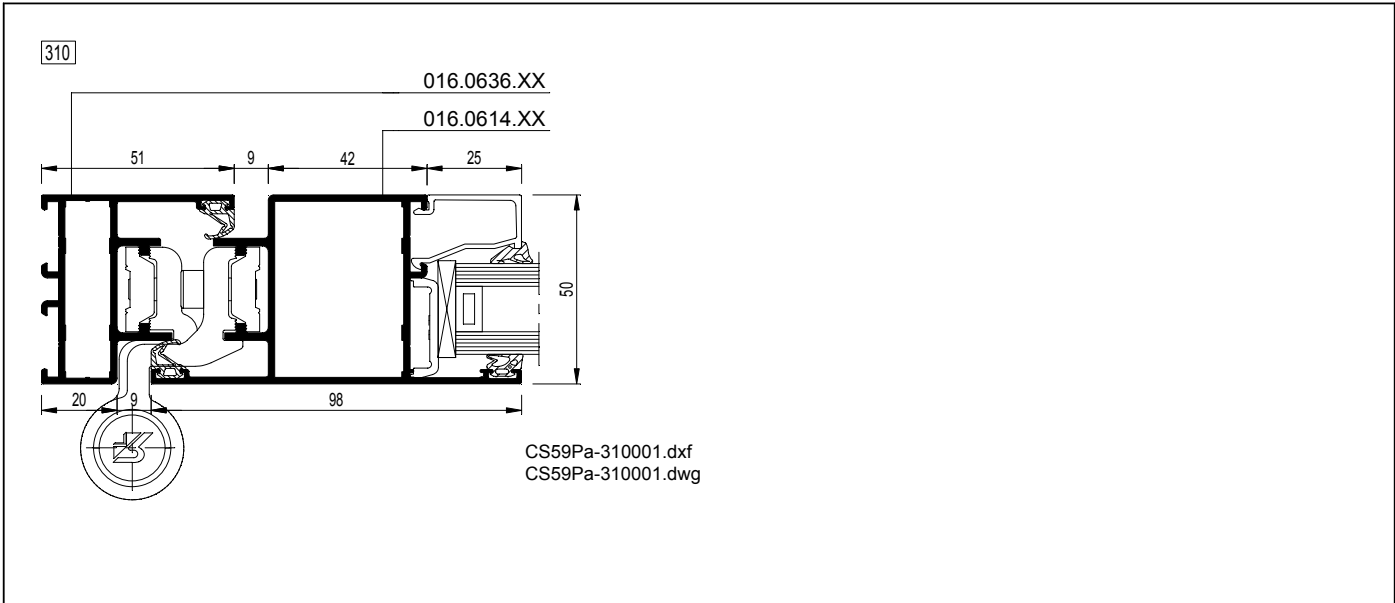
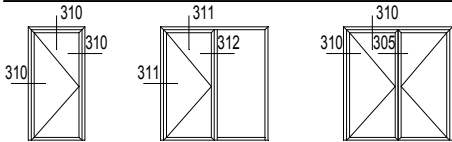

# CS 59Pa-CD

Deuren naar buiten draaiend - Vleugel rondom geperst  
 Portes ouvrant vers l'extérieur - Ouvrant serti tout autour  
 Doors outward opening - Vent crimped all round  
 Türen nach außen öffnend - Rundherum gepresstem Türflügel

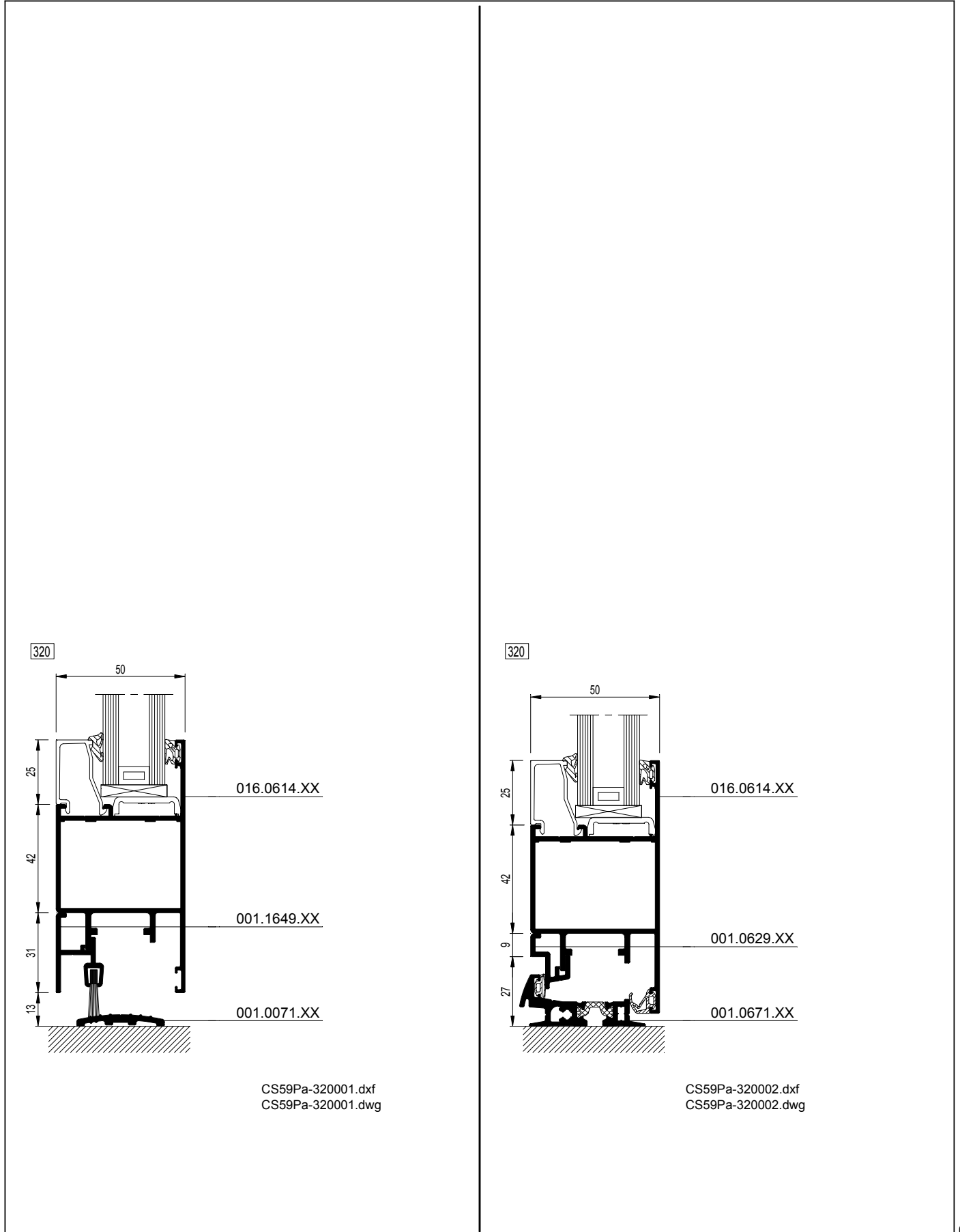
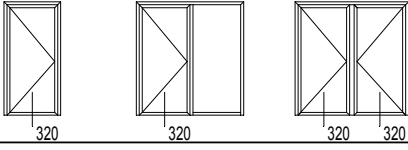

CS59Pa-320001.dxf  
 CS59Pa-320001.dwg

CS59Pa-320002.dxf  
 CS59Pa-320002.dwg

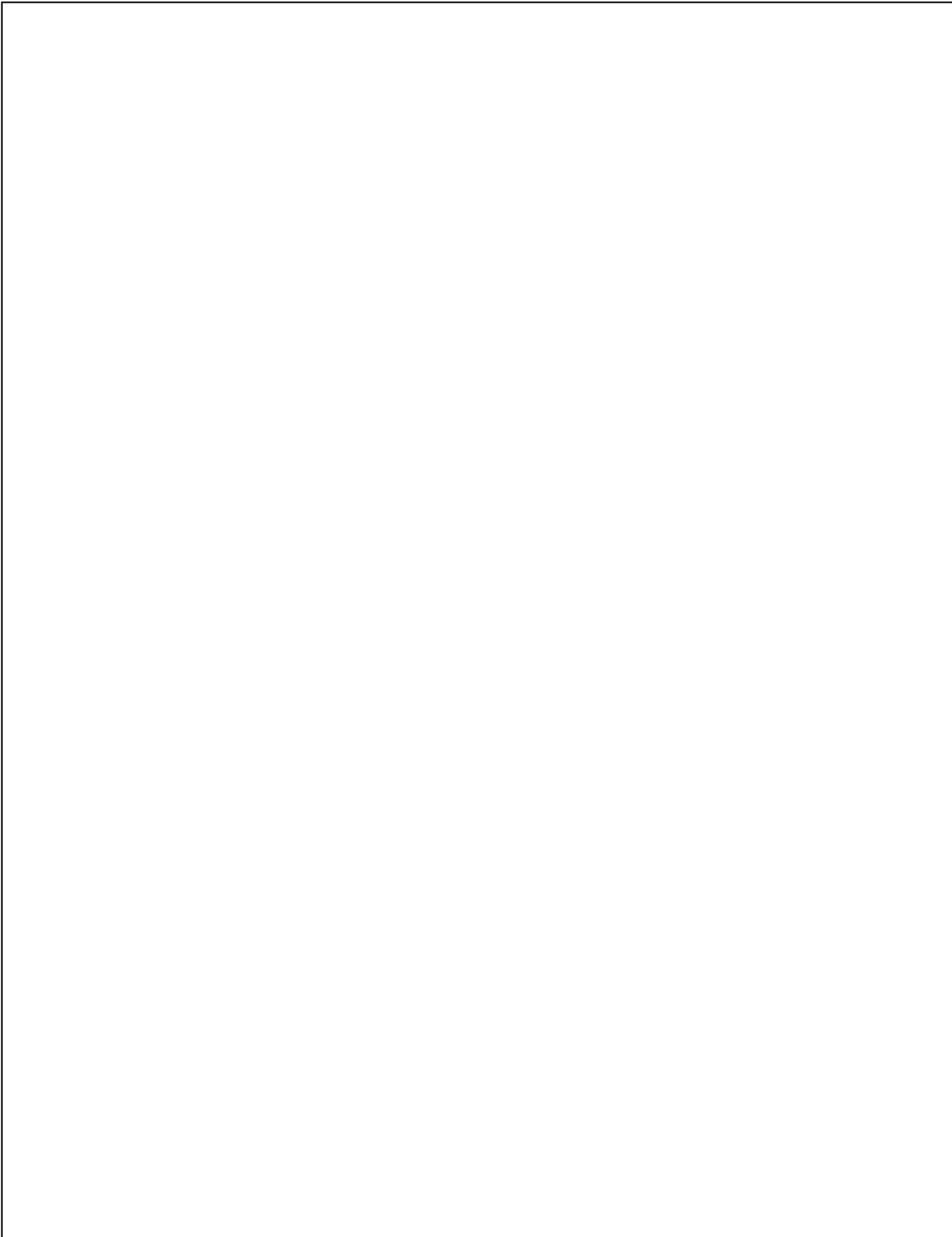



### Connections with other systems

TP 110  
TLS 110  
CP 155  
TR 200

CS 59Pa - CN002  
CS 59Pa - CN002  
CS 59Pa - CN003  
CS 59Pa - CN005

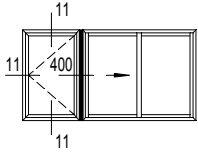

## TP 110

400

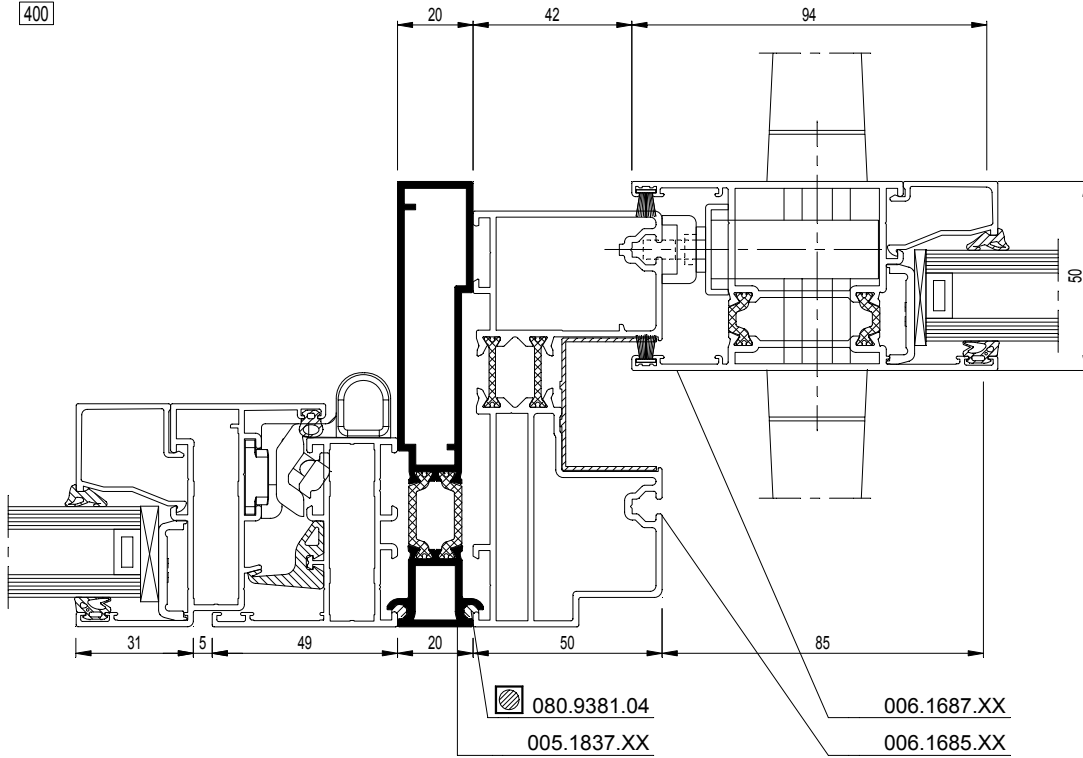

CS59Pa-400001.dxf  
 CS59Pa-400001.dwg

## TLS 110

400

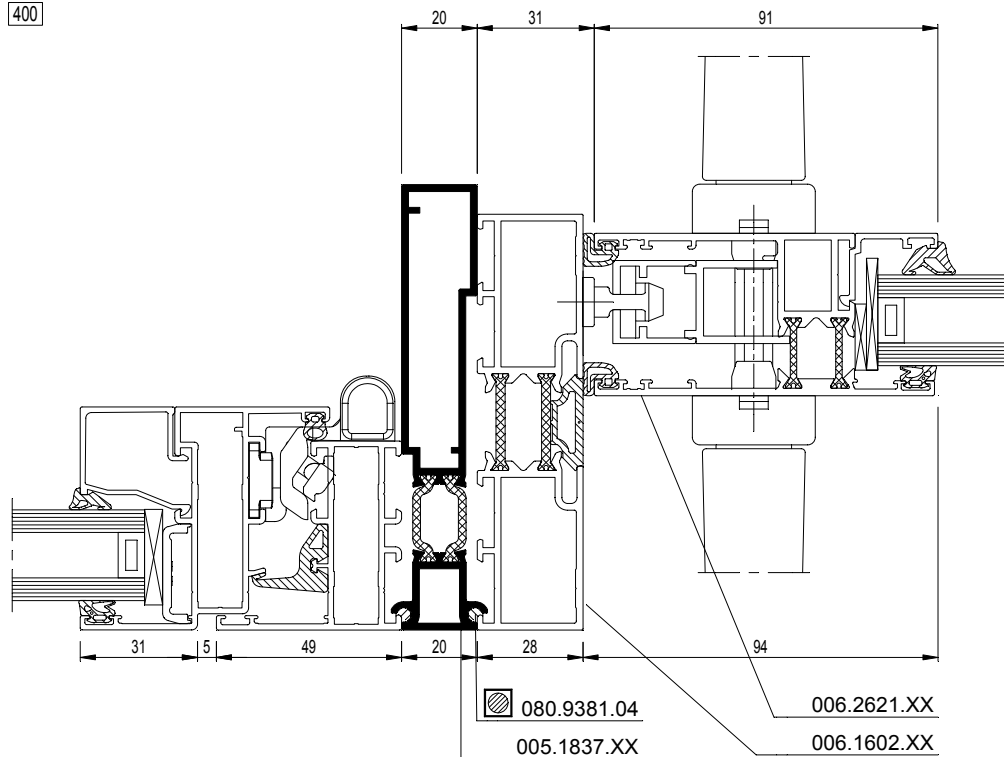

CS59Pa-400002.dxf  
 CS59Pa-400002.dwg



# CS 59Pa

Koppelingen met andere systemen - CP 155  
Combinaisons avec d'autres systèmes - CP 155  
Connections with other systems - CP 155  
Kombinationen mit anderen Systemen - CP 155

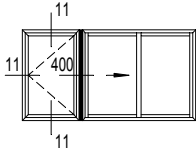

CP 155

400

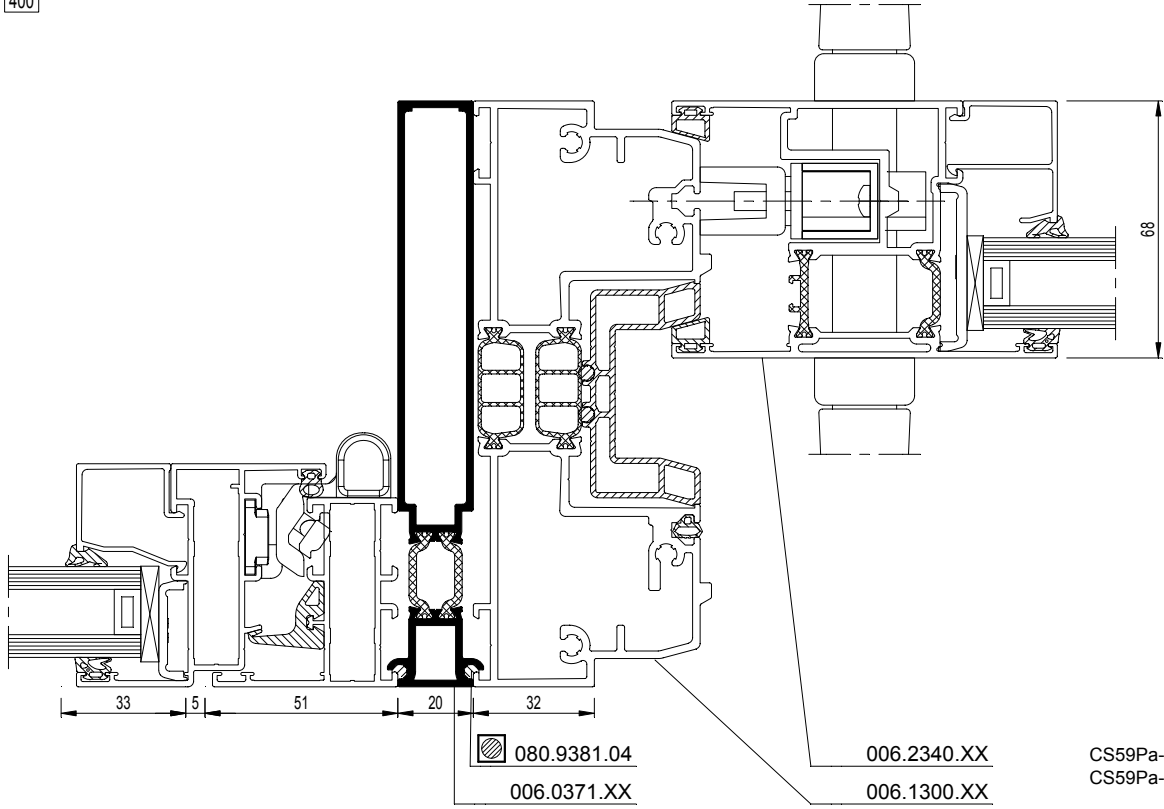

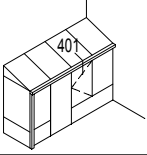

401

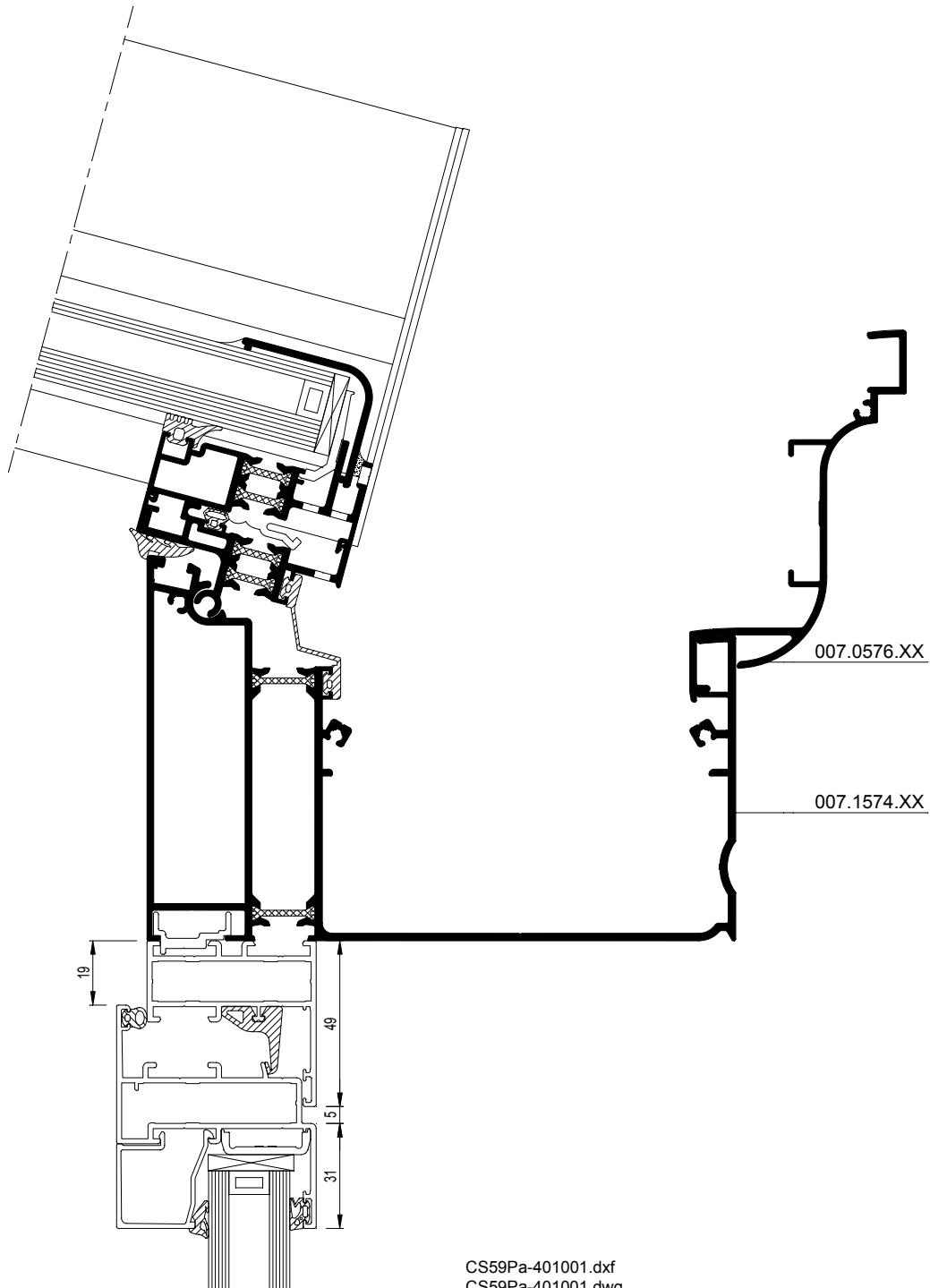

CS59Pa-401001.dxf  
CS59Pa-401001.dwg